

ANNEX I
SUMMARY OF PRODUCT CHARACTERISTICS

1. NAME OF THE MEDICINAL PRODUCT

Hemlibra 30 mg/mL solution for injection
Hemlibra 150 mg/mL solution for injection

2. QUALITATIVE AND QUANTITATIVE COMPOSITION

Hemlibra 30 mg/mL solution for injection

Each mL of solution contains 30 mg of emicizumab*

Each vial of 0.4 mL contains 12 mg of emicizumab at a concentration of 30 mg/mL.

Each vial of 1 mL contains 30 mg of emicizumab at a concentration of 30 mg/mL.

Hemlibra 150 mg/mL solution for injection

Each mL of solution contains 150 mg of emicizumab*

Each vial of 0.4 mL contains 60 mg of emicizumab at a concentration of 150 mg/mL.

Each vial of 0.7 mL contains 105 mg of emicizumab at a concentration of 150 mg/mL.

Each vial of 1 mL contains 150 mg of emicizumab at a concentration of 150 mg/mL.

Each vial of 2 mL contains 300 mg of emicizumab at a concentration of 150 mg/mL.

* Emicizumab is a humanised monoclonal modified immunoglobulin G4 (IgG4) antibody produced using recombinant DNA technology in mammalian Chinese Hamster Ovary (CHO) cells

For the full list of excipients, see section 6.1

3. PHARMACEUTICAL FORM

Solution for injection.

Colourless to slightly yellow solution.

4. CLINICAL PARTICULARS

4.1 Therapeutic indications

Hemlibra is indicated for routine prophylaxis of bleeding episodes in patients with haemophilia A (congenital factor VIII deficiency):

- with factor VIII inhibitors
- without factor VIII inhibitors who have:
 - severe disease (FVIII < 1%)
 - moderate disease (FVIII ≥ 1% and ≤ 5%) with severe bleeding phenotype.

Hemlibra can be used in all age groups.

4.2 Posology and method of administration

Treatment should be initiated under the supervision of a physician experienced in the treatment of haemophilia and/or bleeding disorders.

Posology

Treatment (including routine prophylaxis) with bypassing agents (e.g. activated prothrombin complex concentrate [aPCC] and activated recombinant human FVII [rFVIIa]) should be discontinued the day before starting Hemlibra therapy (see section 4.4).

Factor VIII (FVIII) prophylaxis may be continued for the first 7 days of Hemlibra treatment.

The recommended dose is 3 mg/kg once weekly for the first 4 weeks (loading dose), followed by a maintenance dose from week 5, of either 1.5 mg/kg once weekly, 3 mg/kg every two weeks, or 6 mg/kg every four weeks, all doses administered as a subcutaneous injection.

The loading dose regimen is the same, irrespective of the maintenance dose regimen.

The maintenance dose regimen should be selected based on physician and patient/caregiver dosing regimen preference to support adherence.

The patient dose (in mg) and volume (in mL) should be calculated as follows:

- Loading dose (3 mg/kg) once weekly for the first 4 weeks:
Patient bodyweight (kg) x dose (3 mg/kg) = total amount (mg) of emicizumab to be administered
- Followed by a maintenance dose from week 5, of either 1.5 mg/kg once weekly, 3 mg/kg every two weeks or 6 mg/kg every four weeks:
Patient bodyweight (kg) x dose (1.5; 3 or 6 mg/kg) = total amount (mg) of emicizumab to be administered

The total volume of Hemlibra to be injected subcutaneously is calculated as follows:

Total amount (mg) of emicizumab to be administered ÷ vial concentration (mg/mL) = total volume of Hemlibra (mL) to be injected.

Different Hemlibra concentrations (30 mg/mL and 150 mg/mL) should not be combined in the same syringe when making up the total volume to be administered.

A volume greater than 2 mL per injection should not be administered.

Examples:

Patient's bodyweight of 16 kg, under a maintenance dose regimen of 1.5 mg/kg once weekly:

- Loading dose (first 4 weeks) example: 16 kg x 3 mg/kg = 48 mg of emicizumab needed for the loading dose.
- To calculate the volume to be administered divide calculated dose 48 mg by 150 mg/mL: 48 mg of emicizumab ÷ 150 mg/mL = 0.32 mL of 150 mg/mL Hemlibra concentration to be injected.
- Choose appropriate dose and volume from vial strengths available.
- Maintenance dose (from week 5 on) example: 16 kg x 1.5 mg/kg = 24 mg of emicizumab needed for the maintenance dose.
- To calculate the volume to be administered divide calculated dose 24 mg by 30 mg/mL: 24 mg of emicizumab ÷ 30 mg/mL = 0.8 mL of 30 mg/mL Hemlibra concentration to be injected once weekly.
- Choose appropriate dose and volume from vial strengths available.

Patient's bodyweight of 40 kg, under a maintenance dose regimen of 3 mg/kg every two weeks:

- Loading dose (first 4 weeks) example: $40 \text{ kg} \times 3 \text{ mg/kg} = 120 \text{ mg}$ of emicizumab needed for the loading dose.
- To calculate the volume to be administered divide calculated dose 120 mg by 150 mg/mL:
 $120 \text{ mg of emicizumab} \div 150 \text{ mg/mL} = 0.8 \text{ mL}$ of 150 mg/mL Hemlibra concentration to be injected.
- Choose appropriate dose and volume from vial strengths available.
- Maintenance dose (from week 5 on) example: $40 \text{ kg} \times 3 \text{ mg/kg} = 120 \text{ mg}$ of emicizumab needed for the maintenance dose.
- To calculate the volume to be administered divide calculated dose 120 mg by 150 mg/mL:
 $120 \text{ mg of emicizumab} \div 150 \text{ mg/mL} = 0.8 \text{ mL}$ of 150 mg/mL Hemlibra concentration to be injected every two weeks.
- Choose appropriate dose and volume from vial strengths available.

Patient's bodyweight of 60 kg, under a maintenance dose regimen of 6 mg/kg every four weeks:

- Loading dose (first 4 weeks) example: $60 \text{ kg} \times 3 \text{ mg/kg} = 180 \text{ mg}$ of emicizumab needed for the loading dose.
- To calculate the volume to be administered divide calculated dose 180 mg by 150 mg/mL:
 $180 \text{ mg of emicizumab} \div 150 \text{ mg/mL} = 1.20 \text{ mL}$ of 150 mg/mL Hemlibra concentration to be injected.
- Choose appropriate dose and volume from vial strengths available.
- Maintenance dose (from week 5 on) example: $60 \text{ kg} \times 6 \text{ mg/kg} = 360 \text{ mg}$ of emicizumab needed for the maintenance dose.
- To calculate the volume to be administered divide calculated dose 360 mg by 150 mg/mL:
 $360 \text{ mg of emicizumab} \div 150 \text{ mg/mL} = 2.4 \text{ mL}$ of 150 mg/mL Hemlibra concentration to be injected every four weeks.
- Choose appropriate dose and volume from vial strengths available.

Duration of treatment

Hemlibra is intended for long-term prophylactic treatment.

Dose adjustments during treatment

No dose adjustments of Hemlibra are recommended.

Delayed or missed doses

If a patient misses a scheduled subcutaneous injection of Hemlibra, the patient should be instructed to take the missed dose as soon as possible, up to a day before the day of the next scheduled dose. The patient should then administer the next dose on the usual scheduled dosing day. The patient should not take two doses on the same day to make up for a missed dose.

Special populations

Paediatric

No dose adjustments are recommended in paediatric patients (see section 5.2). There are no data in patients less than 1 year of age.

Elderly

No dose adjustments are recommended in patients ≥ 65 years of age (see sections 5.1 and 5.2). There are no data in patients over 77 years old.

Renal and hepatic impairment

No dose adjustments are recommended in patients with mild, renal or hepatic impairment (see section 5.2). There are limited data available on the use of Hemlibra in patients with moderate renal or hepatic impairment. Emicizumab has not been studied in patients with severe renal or hepatic impairment

Management in the perioperative setting

The safety and efficacy of emicizumab have not been formally evaluated in the surgical setting. Patients have had surgical procedures without discontinuing emicizumab prophylaxis in clinical studies.

If bypassing agents (e.g. aPCC and rFVIIa) are required in the perioperative period, please refer to the dosing guidance on the use of bypassing agents in section 4.4. If FVIII is required in the perioperative period, please refer to section 4.5.

When monitoring a patient's underlying haemostatic activity, please refer to section 4.4 for laboratory tests unaffected by emicizumab.

Immune tolerance induction (ITI)

The safety and efficacy of emicizumab in patients receiving ongoing immune tolerance induction have not yet been established. No data are available.

Method of administration

Hemlibra is for subcutaneous use only, and it should be administered using appropriate aseptic technique (see section 6.6).

The injection should be restricted to the recommended injection sites: the abdomen, the upper outer arms and the thighs (see section 5.2).

Administration of Hemlibra subcutaneous injection in the upper outer arm should be performed by a caregiver or healthcare professional.

Alternating the site of injection may help prevent or reduce injection site reactions (see section 4.8). Hemlibra subcutaneous injection should not be administered into areas where the skin is red, bruised, tender or hard, or areas where there are moles or scars.

During treatment with Hemlibra, other medicinal products for subcutaneous administration should, preferably, be injected at different anatomical sites.

Administration by the patient and/or caregiver

Hemlibra is intended for use under the guidance of a healthcare professional. After proper training in subcutaneous injection technique, a patient may self-inject Hemlibra, or the patient's caregiver may administer it, if their physician determines that it is appropriate.

The physician and the caregiver should determine the appropriateness of the child self-injecting Hemlibra. However, self-administration is not recommended for children below 7 years of age.

For comprehensive instructions on the administration of Hemlibra, see section 6.6 and package leaflet.

4.3 Contraindications

Hypersensitivity to the active substance or to any of the excipients listed in section 6.1.

4.4 Special warnings and precautions for use

Traceability

In order to improve the traceability of biological medicinal products, the name and the batch number of the administered product should be clearly recorded.

Thrombotic microangiopathy associated with Hemlibra and aPCC

Cases of thrombotic microangiopathy (TMA) were reported from a clinical study in patients receiving Hemlibra prophylaxis when on average a cumulative amount of >100U/kg/24 hours of aPCC for 24 hours or more was administered (see section 4.8). Treatment for the TMA events included supportive care with or without plasmapheresis and haemodialysis. Evidence of improvement was seen within one week following discontinuation of aPCC and interruption of Hemlibra. This rapid improvement is distinct from the usual clinical course observed in atypical hemolytic uremic syndrome and classic TMAs, such as thrombotic thrombocytopenic purpura (see section 4.8). One patient resumed Hemlibra following resolution of TMA and continued to be treated safely.

Patients receiving Hemlibra prophylaxis should be monitored for the development of TMA when administering aPCC. The physician should immediately discontinue aPCC and interrupt Hemlibra therapy if clinical symptoms and/or laboratory findings consistent with TMA occur, and manage as clinically indicated. Physicians and patients/caregivers should weigh the benefits and risks of resuming Hemlibra prophylaxis following complete resolution of TMA on a case-by-case basis. In case a bypassing agent is indicated in a patient receiving Hemlibra prophylaxis, see below for dosing guidance on the use of bypassing agents.

Caution should be used when treating patients who are at high risk for TMA (e.g. have a previous medical history or family history of TMA), or those who are receiving concomitant medicinal products known to be a risk factor for the development of TMA (e.g. ciclosporin, quinine, tacrolimus).

Thromboembolism associated with Hemlibra and aPCC

Serious thrombotic events were reported from a clinical study in patients receiving Hemlibra prophylaxis when on average a cumulative amount of >100U/kg/24 hours of aPCC for 24 hours or more was administered (see section 4.8). No cases required anticoagulation therapy. Following discontinuation of aPCC and interruption of Hemlibra, evidence of improvement or resolution was seen within one month (see section 4.8). One patient resumed Hemlibra following resolution of thrombotic event and continued to be treated safely.

Patients receiving Hemlibra prophylaxis should be monitored for the development of thromboembolism when administering aPCC. The physician should immediately discontinue aPCC and interrupt Hemlibra therapy if clinical symptoms, imaging, and/or laboratory findings consistent with thrombotic events occur, and manage as clinically indicated. Physicians and patients/caregivers should weigh the benefits and risks of resuming Hemlibra prophylaxis following complete resolution of thrombotic events on a case-by-case basis. In case a bypassing agent is indicated in a patient receiving Hemlibra prophylaxis, see below for dosing guidance on the use of bypassing agents.

Guidance on the use of bypassing agents in patients receiving Hemlibra prophylaxis

Treatment with bypassing agents should be discontinued the day before starting Hemlibra therapy.

Physicians should discuss with all patients and/or caregivers the exact dose and schedule of bypassing agents to use, if required while receiving Hemlibra prophylaxis.

Hemlibra increases the patient's coagulation potential. The bypassing agent dose required may therefore be lower than that used without Hemlibra prophylaxis. The dose and duration of treatment with bypassing agents will depend on the location and extent of bleeding, and the patient's clinical condition. Use of aPCC should be avoided unless no other treatment options/alternatives are available. If aPCC is indicated in a patient receiving Hemlibra prophylaxis, the initial dose should not exceed 50 U/kg and laboratory monitoring is recommended (including but not restricted to renal monitoring, platelet testing, and evaluation of thrombosis). If bleeding is not controlled with the initial dose of aPCC up to 50 U/kg, additional aPCC doses should be administered under medical guidance or supervision with consideration made to laboratory monitoring for the diagnosis of TMA or thromboembolism and verification of bleeds prior to repeated dosing. The total aPCC dose should not exceed 100 U/kg in the first 24-hours of treatment. Treating physicians must carefully weigh the risk of TMA and thromboembolism against the risk of bleeding when considering aPCC treatment beyond a maximum of 100 U/kg in the first 24-hours.

In clinical studies, no cases of TMA or thrombotic events were observed with use of rFVIIa alone in patients receiving Hemlibra prophylaxis.

Bypassing agent dosing guidance should be followed for at least 6 months following discontinuation of Hemlibra prophylaxis (see section 5.2).

Immunogenicity

Development of neutralising anti-emicizumab antibodies with decreasing emicizumab concentration leading to loss of efficacy has been uncommonly observed during clinical studies (see sections 4.8 and 5.1). Patients with clinical signs of loss of efficacy (e.g. increase in breakthrough bleeding events), should be promptly evaluated to assess the etiology and other therapeutic options should be considered if neutralising anti-emicizumab antibodies are suspected.

Effects of emicizumab on coagulation tests

Emicizumab restores the tenase cofactor activity of missing activated factor VIII (FVIIIa). Coagulation laboratory tests based on intrinsic clotting, including the activated clotting time (ACT), activated partial thromboplastin time (e.g. aPTT), measure the total clotting time including time needed for activation of FVIII to FVIIIa by thrombin. Such intrinsic pathway based tests will yield overly shortened clotting times with emicizumab, which does not require activation by thrombin. The overly shortened intrinsic clotting time will then disturb all single factor assays based on aPTT, such as the one stage FVIII activity assay (see section 4.4, Table 1). However, single factor assays utilising chromogenic or immuno-based methods are not affected by emicizumab and may be used to assess coagulation parameters during treatment, with specific considerations for FVIII chromogenic activity assays as described below.

Chromogenic FVIII activity tests may be manufactured with either human or bovine coagulation proteins. Assays containing human coagulation factors are responsive to emicizumab but may overestimate the clinical haemostatic potential of emicizumab. In contrast, assays containing bovine coagulation factors are insensitive to emicizumab (no activity measured) and can be used to monitor endogenous or infused FVIII activity, or to measure anti FVIII inhibitors.

Emicizumab remains active in the presence of inhibitors against FVIII and so will produce a false negative result in clotting based Bethesda assays for functional inhibition of FVIII. Instead, a chromogenic Bethesda assay utilising a bovine based FVIII chromogenic test that is insensitive to emicizumab may be used.

These two pharmacodynamic markers do not reflect the true haemostatic effect of emicizumab *in vivo* (aPTT is overly shortened and reported FVIII activity may be overestimated) but provide a relative indication of the pro-coagulant effect of emicizumab.

In summary, intrinsic pathway clotting-based laboratory test results in patients treated with Hemlibra should not be used to monitor its activity, determine dosing for factor replacement or anti-coagulation, or measure FVIII inhibitor titers. Caution should be taken if intrinsic pathway clotting based laboratory tests are used, as misinterpretation of their results may lead to under-treatment of patients experiencing bleeding episodes, which can potentially result in severe or life-threatening bleeds.

Laboratory tests affected and unaffected by emicizumab are shown in Table 1 below. Due to its long half-life, these effects on coagulation assays may persist for up to 6 months after the last dose (see section 5.2).

Table 1 Coagulation test results affected and unaffected by emicizumab

Results affected by emicizumab	Results unaffected by emicizumab
<ul style="list-style-type: none"> - Activated partial thromboplastin time (aPTT) - Bethesda assays (clotting-based) for FVIII inhibitor titers - One-stage, aPTT-based, single-factor assays - aPTT-based activated protein C resistance (APC-R) - Activated clotting time (ACT) 	<ul style="list-style-type: none"> - Bethesda assays (bovine chromogenic) for FVIII inhibitor titers - Thrombin time (TT) - One-stage, prothrombin time (PT)-based, single-factor assays - Chromogenic-based single-factor assays other than FVIII¹ - Immuno-based assays (e.g. ELISA, turbidimetric methods) - Genetic tests of coagulation factors (e.g. Factor V Leiden, Prothrombin 20210)

¹For important considerations regarding FVIII chromogenic activity assays, see section 4.4.

Paediatric population

There are no data in children < 1 year of age. The developing haemostatic system in neonates and infants is dynamic and evolving, and the relative concentrations of pro- and anticoagulant proteins in these patients should be taken into consideration when making a benefit-risk assessment, including potential risk of thrombosis (e.g. central venous catheter-related thrombosis).

4.5 Interaction with other medicinal products and other forms of interaction

No adequate or well-controlled interaction studies have been conducted with emicizumab.

Clinical experience indicates a medicinal product interaction exists with emicizumab and aPCC (see sections 4.4 and 4.8).

There is a possibility for hypercoagulability with rFVIIa or FVIII with emicizumab based on preclinical experiments. Emicizumab increases coagulation potential, therefore the FVIIa or FVIII dose required to achieve haemostasis may be lower than when used without Hemlibra prophylaxis.

In case of thrombotic complication, the physician should consider discontinuing rFVIIa or FVIII and interrupt Hemlibra prophylaxis as clinically indicated. Further management should be tailored to the individual clinical circumstances.

- Decision about dose modifications should take into account the half-life of medicinal products; specifically, interruption of emicizumab may not have an immediate effect.
- Monitoring using a FVIII chromogenic assay may guide the administration of coagulation factors, and testing for thrombophilic traits may be considered.

Experience with concomitant administration of anti-fibrinolytics with aPCC or rFVIIa in patients receiving Hemlibra prophylaxis is limited. However, the possibility of thrombotic events should be considered when systemic anti-fibrinolytics are used in combination with aPCC or rFVIIa in patients receiving emicizumab.

4.6 Fertility, pregnancy and lactation

Women of childbearing potential/Contraception

Women of childbearing potential receiving Hemlibra should use effective contraception during, and for at least 6 months after cessation of Hemlibra treatment (see section 5.2).

Pregnancy

There are no clinical studies of emicizumab use in pregnant women. Animal reproduction studies have not been conducted with Hemlibra. It is not known whether emicizumab can cause fetal harm when administered to a pregnant woman or can affect reproductive capacity. Hemlibra should be used during pregnancy only if the potential benefit for the mother outweighs the potential risk to the fetus taking into account that, during pregnancy and after parturition, the risk for thrombosis is increased and that several pregnancy complications are linked to an increased risk for disseminated intravascular coagulation (DIC).

Breast-feeding

It is not known whether emicizumab is excreted in human milk. No studies have been conducted to assess the impact of emicizumab on milk production or its presence in breast milk. Human IgG is known to be present in human milk. A decision must be made whether to discontinue breast-feeding or to discontinue/abstain from Hemlibra therapy taking into account the benefit of breast-feeding for the child and the benefit of therapy for the woman.

Fertility

Animal studies do not indicate direct or indirect harmful effects with respect to reproductive toxicity (see section 5.3). No fertility data are available in humans. Thus, the effect of emicizumab on male and female fertility is unknown.

4.7 Effects on ability to drive and use machines

Hemlibra has no or negligible influence on the ability to drive and use machines.

4.8 Undesirable effects

Summary of the safety profile

The overall safety profile of Hemlibra is based on data from clinical studies and post-marketing surveillance. The most serious adverse drug reactions (ADRs) reported from the clinical studies with Hemlibra were thrombotic microangiopathy (TMA) and thrombotic events, including cavernous sinus thrombosis (CST) and superficial vein thrombosis contemporaneous with skin necrosis (see below and section 4.4).

The most common ADRs reported in $\geq 10\%$ of patients treated with at least one dose of Hemlibra were: injection site reactions (19.4 %), arthralgia (14.2 %) and headache (14.0 %).

In total three patients (0.7 %) in the clinical studies receiving Hemlibra prophylaxis withdrew from treatment due to ADRs, which were TMA, skin necrosis contemporaneous with superficial thrombophlebitis, and headache.

Tabulated list of adverse drug reactions

The following adverse drug reactions (ADRs) are based on data from post-marketing surveillance and pooled data from five phase III clinical studies (adult and adolescent studies [BH29884 - HAVEN 1, BH30071 – HAVEN 3, and BO39182 – HAVEN 4], an all-age group study [BO41423 – HAVEN 6], and a paediatric study [BH29992 - HAVEN 2]), in which a total of 444 patients with haemophilia A received at least one dose of Hemlibra as routine prophylaxis (see section 5.1). Three hundred and seven (69.1 %) of the clinical study participants were adults (of which two were female), 61 (13.7 %) were adolescents (≥ 12 to < 18 years), 71 (16.0 %) were children (≥ 2 to < 12 years) and five (1.1 %) were infants and toddlers (1 month to < 2 years). The median duration of exposure across the studies was 32 weeks (range: 0.1 to 94.3 weeks).

ADRs from the phase III clinical studies and post-marketing surveillance are listed by MedDRA system organ class (Table 2). The corresponding frequency categories for each ADR are based on the following convention: very common ($\geq 1/10$), common ($\geq 1/100$ to $< 1/10$), uncommon ($\geq 1/1,000$ to $< 1/100$), rare ($\geq 1/10,000$ to $< 1/1,000$), very rare ($< 1/10,000$) and not known (cannot be estimated from the available data).

Table 2 Summary of adverse drug reactions from pooled HAVEN clinical studies and post-marketing surveillance with Hemlibra

System Organ Class (SOC)	Adverse reactions (preferred term, MedDRA)	Frequency
Blood and lymphatic system disorders	Thrombotic microangiopathy	Uncommon
Nervous system disorders	Headache	Very common
Vascular disorders	Thrombophlebitis superficial	Uncommon
	Cavernous sinus thrombosis ^a	Uncommon
Gastrointestinal disorders	Diarrhoea	Common
Skin and subcutaneous tissue disorders	Skin necrosis	Uncommon
	Angioedema	Uncommon
	Urticaria	Common
	Rash	Common
Musculoskeletal and connective tissue disorders	Arthralgia	Very common
	Myalgia	Common
General disorders and administration site conditions	Injection site reaction	Very common
	Pyrexia	Common
	Therapeutic response decreased ^b	Uncommon
^a Vascular disorders is a secondary SOC for cavernous sinus thrombosis. ^b Loss of efficacy (therapeutic response decreased) manifest as an increase in breakthrough bleeding has been reported with neutralising anti-emicizumab antibodies with decreasing emicizumab concentration (see Description of selected adverse drug reactions and sections 4.4 and 5.1).		

Description of selected adverse drug reactions

Thrombotic microangiopathy

In pooled phase III clinical studies, TMA events were reported in less than 1 % of patients (3/444) and in 9.7 % of patients (3/31) who received at least one dose of aPCC while being treated with emicizumab. All 3 TMAs occurred when on average a cumulative amount of > 100 U/Kg/24 hours of aPCC for 24 hours or more was administered during a treatment event (see section 4.4). Patients presented with thrombocytopenia, microangiopathic hemolytic anemia, and acute kidney injury, without severe deficiencies in ADAMTS13 activity. One patient resumed Hemlibra following resolution of TMA without recurrence.

Thrombotic events

In pooled phase III clinical studies, serious thrombotic events were reported in less than 1 % of patients (2/444) and in 6.5 % of patients (2/31) who received at least one dose of aPCC while being treated with emicizumab. Both serious thrombotic events occurred when on average a cumulative amount of > 100 U/Kg/24 hours of aPCC for 24 hours or more was administered during a treatment event. One patient resumed Hemlibra following resolution of the thrombotic event without recurrence (see section 4.4).

Characterization of the interaction between emicizumab and aPCC treatment in pivotal clinical studies

There were 82 instances of aPCC treatment* in patients receiving Hemlibra prophylaxis, of which eight instances (10%) consisted of on average a cumulative amount of >100 U/kg/24 hours of aPCC for 24 hours or more; two of the eight instances were associated with thrombotic events and three of the eight instances were associated with TMA (Table 3). No TMA or thrombotic events were associated with the remaining instances of aPCC treatment. Of all instances of aPCC treatment, 68 % consisted of only one infusion < 100 U/kg.

Table 3 Characterisation of aPCC treatment* in the pooled phase III clinical studies

Duration of aPCC treatment	Average cumulative amount of aPCC over 24 hours (U/kg/24 hours)		
	<50	50–100	>100
<24 hours	9	47	13
24-48 hours	0	3	1 ^b
>48 hours	1	1	7 ^{a,a,b}

* An instance of aPCC treatment is defined as all doses of aPCC received by a patient, for any reason, until there was a 36-hour treatment-free break. Includes all instances of aPCC treatment excluding those in the first 7 days and those that occurred 30 days after the discontinuation of Hemlibra.

^a Thrombotic microangiopathy

^b Thrombotic event

Injection site reactions

Injection site reactions (ISRs) were reported very commonly (19.4 %) from the pooled phase III clinical studies. All ISRs observed in the Hemlibra clinical studies were reported as being non-serious and mild to moderate in intensity, and 94.9 % resolved without treatment. The most commonly reported ISR symptoms were injection site erythema (10.6 %), injection site pain (4.1 %), injection site pruritus (2.9 %) and injection site swelling (2.7 %).

Immunogenicity

In the pooled phase III clinical studies with Hemlibra, development of neutralising anti-emicizumab antibodies associated with decreasing emicizumab concentration was uncommon (see section 5.1). One patient, who developed neutralising anti-emicizumab antibodies with decreasing emicizumab concentration, experienced loss of efficacy (manifest as breakthrough bleeding) after five weeks of treatment and later discontinued Hemlibra treatment (see sections 4.4 and 5.1).

Paediatric population

The paediatric population studied comprises a total of 137 patients, of which 5 (3.6 %) were infants and toddlers (1 month to less than 2 years of age), 71 (51.8 %) were children (from 2 to less than 12 years of age) and 61 (44.5 %) were adolescents (from 12 to less than 18 years old). The safety profile of Hemlibra was overall consistent between infants, children, adolescents, and adults.

Reporting of suspected adverse reactions

Reporting suspected adverse reactions after authorisation of the medicinal product is important. It allows continued monitoring of the benefit/risk balance of the medicinal product. Healthcare professionals are asked to report any suspected adverse reactions via the national reporting system listed in [Appendix V](#).

4.9 Overdose

There is limited experience with overdose of Hemlibra.

Symptoms

Accidental overdose may result in hypercoagulability.

Management

Patients who receive an accidental overdose should immediately contact their physician and be monitored closely.

5. PHARMACOLOGICAL PROPERTIES

5.1 Pharmacodynamic properties

Pharmacotherapeutic group: antihemorrhagics, other systemic hemostatics; ATC code: B02BX06

Mechanism of action

Emicizumab is a humanized monoclonal modified immunoglobulin G4 (IgG4) antibody with a bispecific antibody structure.

Emicizumab bridges activated factor IX and factor X to restore the function of missing FVIIIa that is needed for effective haemostasis.

Emicizumab has no structural relationship or sequence homology to FVIII and, as such, does not induce or enhance the development of direct inhibitors to FVIII.

Pharmacodynamic effects

Prophylactic therapy with Hemlibra shortens the aPTT and increases the reported FVIII activity (using a chromogenic assay with human coagulation factors). These two pharmacodynamic markers do not reflect the true haemostatic effect of emicizumab *in vivo* (aPTT is overly shortened and reported FVIII activity may be overestimated) but provide a relative indication of the pro-coagulant effect of emicizumab.

Clinical efficacy and safety

The efficacy of Hemlibra for routine prophylaxis in patients with haemophilia A was evaluated in five clinical studies (three adult and adolescent studies in patients with haemophilia A with or without FVIII inhibitors [HAVEN 1, HAVEN 3, and HAVEN 4], a paediatric study in patients with haemophilia A with FVIII inhibitors [HAVEN 2] and an all-age group study in patients with mild or moderate haemophilia A without FVIII inhibitors [HAVEN 6]).

Clinical studies in adult and adolescent patients with haemophilia A with or without FVIII inhibitors

Patients (aged ≥ 12 years old and > 40 kg) with haemophilia A without FVIII inhibitors (Study BH30071 – HAVEN 3)

The HAVEN 3 study was a randomised, multicentre, open-label, phase III clinical study in 152 adult and adolescent males (aged ≥ 12 years and > 40 kg) with severe haemophilia A without FVIII inhibitors who previously received either episodic (“on demand”) or prophylactic treatment with FVIII. Patients received subcutaneous Hemlibra, 3 mg/kg once weekly for the first four weeks

followed by either 1.5 mg/kg once weekly (Arms A and D) or 3 mg/kg every two weeks (Arm B) thereafter, or no prophylaxis (Arm C). Patients in Arm C could switch to Hemlibra (3 mg/kg every two weeks) after completing at least 24 weeks without prophylaxis. For Arms A and B dose up-titration to 3 mg/kg weekly was allowed after 24 weeks for patients who experienced two or more qualified bleeds (i.e., spontaneous and clinically significant bleeds occurring at steady state). Arm D patients could up-titrate after the second qualifying bleed. At the time of the primary analysis, five patients underwent up-titration of their maintenance dose.

Eighty-nine patients previously treated with episodic (“on demand”) FVIII were randomized in a 2:2:1 ratio to receive Hemlibra either once weekly (Arm A; N = 36), every two weeks (Arm B; N = 35) or no prophylaxis (Arm C; N = 18), with stratification by prior 24-week bleed rate (< 9 or ≥ 9). Sixty-three patients previously treated with prophylactic FVIII were enrolled into Arm D to receive Hemlibra (1.5 mg/kg once weekly).

The primary objective of the study was to evaluate in patients previously treated with episodic FVIII the efficacy of prophylactic Hemlibra weekly (Arm A) or every two weeks (Arm B) compared to no prophylaxis (Arm C) based on the number of bleeds requiring treatment with coagulation factors (see Table 4). Other objectives of the study included evaluation of the randomised comparison of Arms A or B and Arm C for the efficacy of Hemlibra prophylaxis in reducing the number of all bleeds, spontaneous bleeds, joint bleeds, and target joint bleeds (see Table 4), as well as assessing patient treatment preference using a preference survey.

The efficacy of Hemlibra prophylaxis was also compared with previous prophylactic FVIII treatment (Arm D) in patients who had participated in a non-interventional study (NIS) prior to enrollment (see Table 5). Only patients from the NIS were included in this comparison, because bleed and treatment data were collected with the same level of granularity as used in HAVEN 3. The NIS is an observational study with the main objective of capturing detailed clinical data on the bleeding episodes and haemophilia medicinal product use of patients with haemophilia A outside of an interventional study setting.

Patients (aged ≥ 12 years old) with haemophilia A with FVIII inhibitors (Study BH29884 – HAVEN 1)

The HAVEN 1 study was a randomised, multicentre, open-label clinical study in 109 adolescent and adult males (aged ≥ 12 years old) with haemophilia A with FVIII inhibitors who had previously received either episodic or prophylactic treatment with bypassing agents (aPCC and rFVIIa). In the study, patients received weekly Hemlibra prophylaxis (Arms A, C, and D) — 3 mg/kg once weekly for four weeks followed by 1.5 mg/kg once weekly thereafter — or no prophylaxis (Arm B). Patients randomised to Arm B could switch to Hemlibra prophylaxis after completing at least 24 weeks without prophylaxis. Dose up-titration to 3 mg/kg once weekly was allowed after 24 weeks on Hemlibra prophylaxis for patients who experienced two or more qualified bleeds (i.e., spontaneous and verified clinically significant bleeds occurring at steady state). At the time of the primary analysis, two patients underwent up-titration of their maintenance dose to 3 mg/kg once weekly.

Fifty-three patients previously treated with episodic (“on-demand”) bypassing agents were randomised in a 2:1 ratio to receive Hemlibra prophylaxis (Arm A) or no prophylaxis (Arm B), with stratification by prior 24-week bleed rate (< 9 or ≥ 9).

Forty-nine patients previously treated with prophylactic bypassing agents were enrolled in Arm C to receive Hemlibra prophylaxis. Seven patients previously treated with episodic (“on-demand”) bypassing agents who had participated in the NIS prior to enrolment but were unable to enroll in HAVEN 1 prior to the closure of Arms A and B were enrolled in Arm D to receive Hemlibra prophylaxis.

The primary objective of the study was to evaluate, among patients previously treated with episodic (“on-demand”) bypassing agents, the treatment effect of weekly Hemlibra prophylaxis compared with no prophylaxis (Arm A vs. Arm B) on the number of bleeds requiring treatment with coagulation factors over time (minimum of 24 weeks or date of discontinuation) (see Table 6). Other secondary

objectives of the randomised comparison of Arms A and B were the efficacy of weekly Hemlibra prophylaxis in reducing the number of all bleeds, spontaneous bleeds, joint bleeds and target joint bleeds (see Table 6), as well as assessing patients' health-related quality of life (HRQoL) and health status (see Tables 10 and 11). The mean exposure time (+SD) for all patients on study was 21.38 weeks (12.01). For each treatment arm, the mean exposure times (+SD) were 28.86 weeks (8.37) for Arm A, 8.79 (3.62) for Arm B, 21.56 (11.85) for Arm C and 7.08 (3.89) for Arm D. One patient in Arm A withdrew from study prior to initiation of Hemlibra.

The study also evaluated the efficacy of weekly Hemlibra prophylaxis compared with previous episodic (on-demand) and prophylactic bypassing agents (separate comparisons) in patients who had participated in the NIS prior to enrolment (Arms A and C, respectively) (see Table 7).

Patients (aged ≥ 12 years old) with haemophilia A with or without FVIII inhibitors (Study BO39182 – HAVEN 4)

Hemlibra was investigated in a single arm, multicentre, phase III clinical study in 41 adult and adolescent males (aged ≥ 12 years and > 40 kg) who have haemophilia A with FVIII inhibitors or severe haemophilia A without FVIII inhibitors who previously received either episodic (“on demand”) or prophylactic treatment with bypassing agents or FVIII. Patients received Hemlibra prophylaxis – 3 mg/kg once weekly for four weeks followed by 6 mg/kg every four weeks thereafter. The primary objective of the study was to evaluate the efficacy of Hemlibra prophylaxis given every four weeks in maintaining adequate bleed control, based on treated bleeds. Other objectives were to evaluate the clinical efficacy of Hemlibra prophylaxis on all bleeds, treated spontaneous bleeds, treated joint bleeds and treated target joint bleeds (see Table 8). Patient treatment preference was also assessed using a preference survey.

Patients (all ages) with mild or moderate haemophilia A without FVIII inhibitors (Study BO41423 – HAVEN 6)

The HAVEN 6 study was a multicentre, open-label, single-arm phase III clinical study in 71 emicizumab-treated patients (all ages) with mild (n = 20 [28.2%]) or moderate (n = 51 [71.8%]) haemophilia A without FVIII inhibitors for whom prophylaxis was indicated, as assessed by the investigator. Most patients were male (69 patients [97.2%]), and 2 were female (2.8%). At study entry, 34 patients (47.9%) were on episodic and 37 patients (52.1%) were on prophylactic treatment with FVIII. Patients received subcutaneous Hemlibra 3 mg/kg once weekly for the first four weeks followed by patient preference for one of the following maintenance regimens, from week 5: 1.5 mg/kg once weekly (n = 24 [33.8%]), 3 mg/kg every two weeks (n = 39 [54.9%]) or 6 mg/kg every four weeks (n = 8 [11.3%]). Dose up-titration to 3 mg/kg weekly was allowed after 24 weeks for patients who experienced two or more qualified bleeds (i.e., spontaneous and clinically significant bleeds occurring at steady state). At the time of interim analysis, no patients underwent up-titration of their maintenance dose.

The primary efficacy objective of the study was to evaluate the efficacy of Hemlibra prophylaxis based on the number of bleeds requiring treatment with coagulation factors over time (i.e., bleed rate of treated bleeds, see Table 9). Other objectives were to evaluate the efficacy of Hemlibra prophylaxis based on the number of all bleeds, spontaneous bleeds, joint bleeds, and target joint bleeds over time, as well as assessing patient reported HRQoL using the Comprehensive Assessment Tool of Challenges in Haemophilia (CATCH) questionnaire over time.

Efficacy results

HAVEN 3

The efficacy results of Hemlibra prophylaxis compared with no prophylaxis with respect to rate of treated bleeds, all bleeds, treated spontaneous bleeds, treated joint bleeds, and treated target joint bleeds are shown in Table 4.

Table 4 HAVEN 3 study: Annualised Bleed Rate for Hemlibra prophylaxis arm versus no prophylaxis arm in patients ≥ 12 years of age without FVIII inhibitors

Endpoint	Arm C: No prophylaxis (N = 18)	Arm A: Hemlibra 1.5 mg/kg weekly (N = 36)	Arm B: Hemlibra 3 mg/kg every 2 weeks (N = 35)
Treated bleeds			
ABR (95% CI)	38.2 (22.9; 63.8)	1.5 (0.9; 2.5)	1.3 (0.8; 2.3)
% reduction (RR), p-value	NA	96% (0.04), < 0.0001	97% (0.03), < 0.0001
% patients with 0 bleeds (95% CI)	0.0 (0.0; 18.5)	55.6 (38.1; 72.1)	60.0 (42.1; 76.1)
Median ABR (IQR)	40.4 (25.3; 56.7)	0 (0; 2.5)	0 (0; 1.9)
All bleeds			
ABR (95% CI)	47.6 (28.5; 79.6)	2.5 (1.6; 3.9)	2.6 (1.6; 4.3)
% reduction (RR), p-value	NA	95% (0.05 <0.0001	94% (0.06), <0.0001
% patients with 0 bleeds (95% CI)	0 (0.0;18.5)	50 (32.9; 67.1)	40 (23.9; 57.9)
Treated spontaneous bleeds			
ABR (95% CI)	15.6 (7.6; 31.9)	1.0 (0.5; 1.9)	0.3 (0.1; 0.8)
% reduction (RR), p-value	NA	94% (0.06), <0.0001	98% (0.02), <0.0001
% patients with 0 bleeds (95% CI)	22.2 (6.4; 47.6)	66.7 (49.0; 81.4)	88.6 (73.3; 96.8)
Treated joint bleeds			
ABR (95% CI)	26.5 (14.67; 47.79)	1.1 (0.59; 1.89)	0.9 (0.44; 1.67)
% reduction (RR), p-value	NA	96% (0.04), <0.0001	97% (0.03), <0.0001
% patients with 0 bleeds (95% CI)	0 (0; 18.5)	58.3 (40.8; 74.5)	74.3 (56.7; 87.5)

Endpoint	Arm C: No prophylaxis (N = 18)	Arm A: Hemlibra 1.5 mg/kg weekly (N = 36)	Arm B: Hemlibra 3 mg/kg every 2 weeks (N = 35)
Treated target joint bleeds			
ABR (95% CI)	13.0 (5.2; 32.3)	0.6 (0.3; 1.4)	0.7 (0.3; 1.6)
% reduction (RR), p-value	NA	95% (0.05), <0.0001	95% (0.05), <0.0001
% patients with 0 bleeds (95% CI)	27.8 (9.7; 53.5)	69.4 (51.9; 83.7)	77.1 (59.9; 89.6)
<p>Rate ratio, and confidence interval (CI) come from negative binomial regression (NBR) model and p-value from Stratified Wald test, comparing bleed rate between specified arms.</p> <p>Arm C: includes no prophylaxis period only.</p> <p>Bleed definitions adapted based on ISTH criteria.</p> <p>Treated bleeds = bleeds treated with FVIII</p> <p>All bleeds = bleeds treated and not treated with FVIII.</p> <p>Includes data before up-titration only, for patients whose dose was up-titrated.</p> <p>Patients exposed to emicizumab started with a loading dose of 3 mg/kg/week for 4 weeks.</p> <p>ABR= Annualised Bleed Rate; CI= confidence interval; RR= rate ratio; IQR= interquartile range, 25th percentile to 75th percentile, NA=Not Applicable</p>			

In the HAVEN 3 clinical study intra-patient analysis, Hemlibra prophylaxis resulted in a statistically significant (p<0.0001) reduction (68 %) in bleed rate for treated bleeds compared with previous FVIII prophylaxis collected in the NIS prior to enrollment (see Table 5).

Table 5 HAVEN 3 study: Intra-patient comparison of Annualised Bleed Rate (treated bleeds) with Hemlibra prophylaxis versus previous FVIII prophylaxis

Endpoint	Arm D NIS: Previous FVIII prophylaxis (N = 48)	Arm D: Hemlibra 1.5 mg/kg weekly (N = 48)
Median efficacy period (weeks)	30.1	33.7
Treated bleeds		
ABR (95% CI)	4.8 (3.2; 7.1)	1.5 (1; 2.3)
% reduction (RR), p-value	68% (0.32), <0.0001	
% patients with zero bleeds (95% CI)	39.6 (25.8; 54.7)	54.2 (39.2; 68.6)
Median ABR (IQR)	1.8 (0; 7.6)	0 (0; 2.1)
<p>Rate ratio and confidence interval (CI) comes from negative binomial regression (NBR) model and p-value from Stratified Wald test, comparing ABR between specified arms.</p> <p>Intra-patient comparator data from the NIS. Only patients who participated in the NIS and in study HAVEN 3 are included.</p> <p>Includes data before up-titration only, for patients whose dose was up-titrated.</p> <p>Treated bleeds = bleeds treated with FVIII. Bleed definitions adapted based on ISTH criteria. ABR= Annualised Bleed Rate; CI= confidence interval; RR= rate ratio; IQR=interquartile range, 25th percentile to 75th percentile</p> <p>Although a higher adherence was observed with emicizumab prophylaxis than with prior FVIII prophylaxis, no difference in ABR in patients with ≥80% or < 80% compliant doses on FVIII prophylaxis according to standard label requirements could be identified (data to be interpreted with caution due to small sample sizes).</p> <p>Due to the short half-life of FVIII, no carryover effect is assumed after its discontinuation.</p> <p>Only the first five emicizumab doses had to be administered under supervision to ensure safety and injection technique proficiency. Similar to FVIII prophylaxis, self-administration at home was allowed for all subsequent emicizumab doses.</p> <p>All patients were treated by haemophilia experts who confirmed that adequate FVIII prophylaxis was administered to patients included in the intra-patient comparison, supporting equivalent usual prophylaxis care across sites and patients.</p>		

HAVEN 1

The efficacy results of Hemlibra prophylaxis compared with no prophylaxis with respect to rate of treated bleeds, all bleeds, treated spontaneous bleeds, treated joint bleeds, and treated target joint bleeds are shown in Table 6.

Table 6 HAVEN 1: Annualised Bleed Rate with Hemlibra prophylaxis arm versus no prophylaxis arm in patients ≥ 12 years of age with FVIII inhibitors

Endpoint	Arm B: no prophylaxis	Arm A: 1.5 mg/kg Hemlibra weekly
	N=18	N=35
Treated bleeds		
ABR (95% CI)	23.3 (12.33; 43.89)	2.9 (1.69; 5.02)
% reduction (RR), p-value	87% (0.13), < 0.0001	
% patients with 0 bleeds (95% CI)	5.6 (0.1; 27.3)	62.9 (44.9; 78.5)
Median ABR (IQR)	18.8 (12.97;35.08)	0 (0; 3.73)
All bleeds		
ABR (95% CI)	28.3 (16.79; 47.76)	5.5 (3.58; 8.60)
% reduction (RR), p-value	80% (0.20), < 0.0001	
% patients with 0 bleeds (95% CI)	5.6 (0.1; 27.3)	37.1 (21.5; 55.1)
Treated spontaneous bleeds		
ABR (95% CI)	16.8 (9.94; 28.30)	1.3 (0.73; 2.19)
% reduction (RR), p-value	92% (0.08), < 0.0001	
% patients with 0 bleeds (95% CI)	11.1 (1.4; 34.7)	68.6 (50.7; 83.1)
Treated joint bleeds		
ABR (95% CI)	6.7 (1.99; 22.42)	0.8 (0.26; 2.20)
% reduction (RR), p-value	89% (0.11), 0.0050	
% patients with 0 bleeds (95% CI)	50.0 (26.0; 74.0)	85.7 (69.7; 95.2)
Treated target joint bleeds		
ABR (95% CI)	3.0 (0.96; 9.13)	0.1 (0.03; 0.58)
% reduction (RR), p-value	95% (0.05), 0.0002	
% patients with 0 bleeds (95% CI)	50.0 (26.0; 74.0)	94.3 (80.8; 99.3)
<p>Rate ratio, and confidence interval (CI) come from negative binomial regression (NBR) model and p-value from Stratified Wald test, comparing bleed rate between specified arms.</p> <p>Arm B: includes no prophylaxis period only.</p> <p>Bleed definitions adapted based on ISTH criteria.</p> <p>Treated bleeds = bleeds treated with bypassing agents.</p> <p>All bleeds = bleeds treated and not treated with bypassing agents.</p> <p>Includes data before up-titration only, for patients whose dose was up-titrated.</p> <p>Patients exposed to emicizumab started with a loading dose of 3 mg/kg/week for 4 weeks.</p> <p>ABR= Annualised Bleed Rate; CI= confidence interval; RR= rate ratio; IQR= interquartile range, 25th percentile to 75th percentile.</p>		

In the HAVEN 1 intra-patient analysis, Hemlibra prophylaxis resulted in statistically significant ($p = 0.0003$) and clinically meaningful reduction (79 %) in bleed rate for treated bleeds compared with previous bypassing agent prophylaxis collected in the NIS prior to enrolment (see Table 7).

Table 7 HAVEN 1: Intra-patient comparison of Annualised Bleed Rate (treated bleeds) with Hemlibra prophylaxis versus previous bypassing agent prophylaxis (NIS patients)

Endpoint	Arm C_{NIS}: previous bypassing agent prophylaxis	Arm C: Hemlibra 1.5 mg/kg weekly
	N=24	N=24
Treated bleeds		
ABR (95% CI)	15.7 (11.08; 22.29)	3.3 (1.33; 8.08)
% patients with 0 bleeds (95% CI)	12.5 (2.7; 32.4)	70.8 (48.9; 87.4)
Median ABR (IQR)	12.0 (5.73; 24.22)	0.0 (0.00; 2.23)
% reduction (RR), p-value	79% (0.21), 0.0003	
<p>Rate ratio and confidence interval (CI) comes from negative binomial regression (NBR) model and p-value from Stratified Wald test, comparing ABR between specified arms.</p> <p>Intra-patient comparator data from the NIS.</p> <p>Only patients who participated in the NIS and in study HAVEN 1 are included.</p> <p>Includes data before up-titration only, for patients whose dose was up-titrated.</p> <p>Treated bleeds = bleeds treated with bypassing agents.</p> <p>Bleed definitions adapted based on ISTH criteria.</p> <p>ABR= Annualised Bleed Rate; CI= confidence interval; RR= rate ratio; IQR=interquartile range, 25th percentile to 75th percentile</p> <p>Although a higher adherence was observed with emicizumab prophylaxis than with prior bypassing agent (BPA) prophylaxis, no difference in ABR in patients with $\geq 80\%$ or $< 80\%$ compliant doses on BPA prophylaxis according to standard label requirements could be identified (data to be interpreted with caution due to small sample sizes).</p> <p>Due to the short half-life of bypassing agents, no carryover effect is assumed after its discontinuation.</p> <p>Only the first five emicizumab doses had to be administered under supervision to ensure safety and injection technique proficiency. Similar to BPA prophylaxis, self-administration at home was allowed for all subsequent emicizumab doses.</p>		

HAVEN 4

Primary analysis efficacy results of Hemlibra prophylaxis every four weeks with respect to rate of treated bleeds, all bleeds, treated spontaneous bleeds, treated joint bleeds, and treated target joint bleeds are shown in Table 8. Forty one patients ≥ 12 years old were evaluated for efficacy with a median observation time of 25.6 weeks (range: 24.1-29.4).

Table 8 HAVEN 4: Annualised Bleed Rate with Hemlibra prophylaxis in patients ≥12 years of age with or without FVIII inhibitors

Endpoints	Hemlibra 6mg/kg Q4W		
	^a ABR (95% CI)	^b Median ABR (IQR)	% Zero Bleeds (95%CI)
N	41	41	41
Treated bleeds	2.4 (1.4; 4.3)	0.0 (0.0; 2.1)	56.1 (39.7; 71.5)
All bleeds	4.5 (3.1; 6.6)	2.1 (0.0; 5.9)	29.3 (16.1; 45.5)
Treated spontaneous bleeds	0.6 (0.3;1.5)	0.0 (0.0; 0.0)	82.9 (67.9;92.8)
Treated joint bleeds	1.7 (0.8; 3.7)	0.0 (0.0; 1.9)	70.7 (54.5; 83.9)
Treated target joint bleeds	1.0 (0.3; 3.3)	0.0 (0.0;0.0)	85.4 (70.8; 94.4)

^a Calculated with negative binomial regression (NBR) model
^b Calculated ABR
Bleed definitions adapted based on ISTH criteria
Treated bleeds: bleeds treated with FVIII or rFVIIa
All bleeds: bleeds treated and not treated with FVIII or rFVIIa
Patients exposed to emicizumab started with a loading dose of 3mg/kg/week for 4 weeks.
ABR=Annualised Bleed Rate, CI=confidence interval; IQR=interquartile range; 25th percentile to 75th percentile ; Q4W=once every four week prophylaxis

HAVEN 6 (interim analysis)

Fifty-one patients with moderate haemophilia A aged 2 to 56 years old were evaluated for efficacy with a median observation time of 30.4 weeks (range: 17.4 - 61.7). Interim efficacy results of Hemlibra prophylaxis in patients with moderate haemophilia A (see section 4.1) with respect to rate of treated bleeds, all bleeds, treated spontaneous bleeds, treated joint bleeds, and treated target joint bleeds are shown in Table 9.

Table 9 HAVEN 6: Annualised Bleed Rate with Hemlibra prophylaxis in patients with moderate haemophilia A without FVIII inhibitors

Endpoints	^c Hemlibra 1.5 mg/kg QW, 3 mg/kg Q2W or 6 mg/kg Q4W		
	^a ABR (95% CI)	^b Median ABR (IQR)	% Zero Bleeds (95%CI)
N	51	51	51
Treated bleeds	0.9 [0.43; 1.89]	0.0 [0.00; 0.00]	78.4 [64.7; 88.7]
All bleeds	2.6 [1.81; 3.81]	1.7 [0.00; 3.90]	43.1 [29.3; 57.8]
Treated spontaneous bleeds	0.1 [0.03; 0.30]	0.0 [0.00; 0.00]	94.1 [83.8; 98.8]
Treated joint bleeds	0.3 [0.10; 0.84]	0.0 [0.00; 0.00]	90.2 [78.6; 96.7]
Treated target joint bleeds	0.1 [0.02; 0.26]	0.0 [0.00; 0.00]	96.1 [86.5; 99.5]

^a Calculated with negative binomial regression (NBR) model
^b Calculated ABR
Bleed definitions adapted based on ISTH criteria
Treated bleeds: bleeds treated with FVIII.
All bleeds: bleeds treated and not treated with FVIII.
Patients exposed to emicizumab started with a loading dose of 3 mg/kg/week for 4 weeks.
ABR=Annualised Bleed Rate, CI=confidence interval; IQR=interquartile range; 25th percentile to 75th percentile;
QW=once every week prophylaxis; Q2W=once every two weeks prophylaxis; Q4W=once every four weeks prophylaxis
^c 1.5 mg/kg QW (n = 16); 3 mg/kg Q2W (n = 30); 6 mg/kg Q4W (n = 5)

Health-related outcome measures

The HAVEN clinical studies evaluated HRQoL and health-status using clinical outcome assessment measures. HAVEN 1 and 2 used the Haemophilia-Specific Quality of Life (Haem-A-QoL) questionnaire for adults (≥ 18 years) and its adolescent version (Haemo-QoL-SF, for 8 to <18 years), respectively, for which the Physical Health Score (i.e. painful swellings, presence of joint pain, pain with movement, difficulty walking far and needing more time to get ready) and Total Score (summary of all scores) were protocol defined endpoints of interest. HAVEN 2 additionally used the Adapted InhibQoL with Aspects of Caregiver Burden questionnaire to obtain caregiver-report of HRQoL in paediatric patients < 12 years. HAVEN 6 assessed HRQoL in adult and paediatric patients, as well as caregivers of paediatric patients, using the Comprehensive Assessment Tool of Challenges in Haemophilia (CATCH) questionnaire. The domains of risk perception and impact of haemophilia on daily activities, social activities, recreational activities, and work/school, as well as preoccupation and treatment burden were examined. To measure change in health status, the Index Utility Score (IUS) and the Visual Analog Scale (VAS) from the EuroQoL Five-Dimension Five-Levels Questionnaire (EQ-5D-5L) were examined.

HAVEN 1 health-related outcomes

In this study baseline Total Scores (mean = 41.14 and 44.58, respectively) and Physical Health scale scores (mean = 52.41 and 57.19, respectively) were similar for Hemlibra prophylaxis and no prophylaxis. Table 10 provides a summary of the comparison between the Hemlibra prophylaxis arm (Arm A) and the no prophylaxis arm (Arm B) on the Haem-A-QoL Total Score and Physical Health scale after 24 weeks of treatment adjusting for baseline. Weekly Hemlibra prophylaxis showed a statistically significant and clinically meaningful improvement compared with no prophylaxis in the pre-specified endpoints of Haem-A-QoL Physical Health Scale score at the Week 25 assessment.

Table 10 HAVEN 1: Change in Haem-A-QoL Physical Health and Total score with Hemlibra prophylaxis versus no prophylaxis in patients ≥ 18 years with FVIII inhibitors

Haem-A-QoL at week 25	Arm B: no prophylaxis (N=14)	Arm A: Hemlibra 1.5 mg/kg weekly (N=25)
Physical health score (range 0 to 100)		
Adjusted mean	54.17	32.61
Difference in adjusted means (95% CI)	21.55 (7.89, 35.22)	
p-value	0.0029	
Total score (range 0 to 100)		
Adjusted mean	43.21	29.2
Difference in adjusted means (95% CI)	14.01 (5.56, 22.45)	
Arm B: includes no prophylaxis period only. Includes data before up-titration only, for patients whose dose was up-titrated. Patients exposed to emicizumab started with a loading dose of 3 mg/kg/week for 4 weeks. Haem-A_QoL scales range from 0 to 100; lower scores are reflective of better HRQoL. Clinically meaningful difference: Total score: 7 points; Physical Health: 10 points. Analyses are based on data from individuals who provided responses at both baseline and Week 25 assessments.		

HAVEN 1 health status outcomes

Table 11 provides a summary of the comparison between the Hemlibra prophylaxis arm (Arm A) and the no prophylaxis arm (Arm B) on the EQ-5D-5L IUS and VAS after 24 weeks of treatment adjusting for baseline.

Table 11 HAVEN 1: EQ-5D-5L scores in patients ≥ 12 years at week 25

EQ-5D-5L scores after 24 weeks	Arm B: no prophylaxis (N=16)	Arm A: Hemlibra 1.5 mg/kg weekly (N=29)
Visual Analogue Scale		
Adjusted mean	74.36	84.08
Difference in adjusted means (95% CI)	-9.72 (-17.62, -1.82)	
Index Utility Score		
Adjusted mean	0.65	0.81
Difference in adjusted means (95% CI)	-0.16 (-0.25, -0.07)	
Arm B: includes no prophylaxis period only. Includes data before up-titration only, for patients whose dose was up-titrated. Patients exposed to emicizumab started with a loading dose of 3 mg/kg/week for 4 weeks. Higher scores indicate better quality of life. Clinically meaningful difference: VAS: 7 points, Index Utility Score: 0.07 points Analyses are based on data from individuals who provided responses at both baseline and Week 25 assessments.		

HAVEN 6 health-related outcomes

In HAVEN 6, HRQoL for patients of all ages with moderate haemophilia A was evaluated at week 25 based on the CATCH questionnaire. The CATCH questionnaire (version 1.0) is a validated instrument that assesses the effect of haemophilia and its treatment. Different versions of the questionnaire exist for adult patients, paediatric patients and caregivers of paediatric patients.

Health-related quality of life on Hemlibra prophylaxis remained generally stable, with improvement in the treatment burden domain of CATCH consistently observed across respondent groups.

Paediatric population

Paediatric patients (age < 12 years old, or 12 to 17 years old weighing < 40 kg) with haemophilia A with FVIII inhibitors (Study BH29992 – HAVEN 2)

Hemlibra weekly prophylaxis was evaluated in a single-arm, multicentre, open-label clinical study in paediatric patients (age < 12 years old, or 12 to 17 years old weighing < 40 kg) with haemophilia A with FVIII inhibitors. Patients received Hemlibra prophylaxis at 3 mg/kg once weekly for the first 4 weeks followed by 1.5 mg/kg once weekly thereafter.

The study evaluated the pharmacokinetics (PK), safety, and efficacy including the efficacy of weekly Hemlibra prophylaxis compared with previous episodic and prophylactic bypassing agent treatment in patients who had participated in the NIS prior to enrolment (intra-patient comparison).

Efficacy results

HAVEN 2 (interim analysis)

At the time of the interim analysis, efficacy was evaluated in 59 patients who were < 12 years old and had been receiving weekly Hemlibra prophylaxis for at least 12 weeks, including four patients aged < 2 years old, 17 patients aged 2 to < 6 years, 38 patients aged 6 to < 12 years old. Annualised bleed rate and percent of patients with zero bleeds were calculated (see Table 12). The median observation time for these patients was 29.6 weeks (range: 18.4 to 63.0 weeks).

Table 12 HAVEN 2: Overview of efficacy (interim analysis)

Endpoint	^aABR (95% CI) ^bN = 59	^cMedian ABR (IQR) ^bN = 59	% Zero Bleeds (95% CI) ^bN = 59
Treated bleeds	0.3 (0.1; 0.5)	0 (0; 0)	86.4 (75; 94)
All bleeds	3.8 (2.2; 6.5)	0 (0; 3.4)	55.9 (42.4; 68.8)
Treated spontaneous bleeds	0 (0; 0.2)	0 (0; 0)	98.3 (90.9; 100)
Treated joint bleeds	0.2 (0.1; 0.4)	0 (0; 0)	89.8 (79.2; 96.2)
Treated target joint bleeds	0.1 (0; 0.7)	0 (0; 0)	96.6 (88.3; 99.6)
<p>ABR = annualised bleed rate; CI = confidence interval; IQR = interquartile range, 25th percentile to 75th percentile</p> <p>^a Calculated with negative binomial regression (NBR) model.</p> <p>^b Efficacy data from treated patients aged < 12 years who had been on study HAVEN 2 for at least 12 weeks (N = 59), as the study aimed to primarily investigate treatment effect based on age.</p> <p>^c Calculated ABR</p> <p>Bleed definitions adapted based on ISTH criteria.</p> <p>Treated bleeds: bleeds treated with bypassing agents.</p> <p>All bleeds: bleeds treated and not treated with bypassing agents.</p> <p>Patients exposed to emicizumab started with a loading dose of 3 mg/kg/week for 4 weeks.</p>			

In the intra-patient analysis, Hemlibra weekly prophylaxis resulted in a clinically meaningful reduction (98 %) in treated bleed rate in 18 paediatric patients who had at least 12 weeks of Hemlibra prophylaxis compared to their bleed rate collected in the NIS prior to enrolment (Table 13).

Table 13 HAVEN 2: Intra-patient comparison of Annualised Bleed Rate (treated bleeds) with Hemlibra prophylaxis versus previous bypassing agent prophylaxis

Endpoint	Previous bypassing agent treatment* (N = 18)	Hemlibra prophylaxis (N = 18)
Treated bleeds		
ABR (95% CI)	19.8 (15.3; 25.7)	0.4 (0.15; 0.88)
% reduction (RR)	98% (0.02)	
% patients with zero bleeds (95% CI)	5.6 (0.1; 27.3)	77.8 (52.4; 93.6)
Median ABR (IQR)	16.2 (11.49; 25.78)	0 (0; 0)
<p>* Previous prophylactic treatment for 15 of the 18 patients; previous episodic (on-demand) treatment for 3 subject</p> <p>Rate ratio and confidence interval (CI) comes from negative binomial regression (NBR) model and p-value from Stratified Wald test, comparing ABR between specified arms.</p> <p>Intra-patient comparator data from the NIS.</p> <p>Only patients who participated in the NIS and in study HAVEN 2 are included.</p> <p>Bleed definitions adapted based on ISTH criteria.</p> <p>Treated bleeds: bleeds treated with bypassing agents.</p> <p>Patients exposed to emicizumab started with a loading dose of 3 mg/kg/week for 4 weeks.</p> <p>ABR= Annualised Bleed Rate; CI= confidence interval; RR= rate ratio; IQR=interquartile range, 25th percentile to 75th percentile</p> <p>Although a higher adherence was observed with emicizumab prophylaxis than with prior bypassing agent (BPA) prophylaxis, no difference in ABR in patients with $\geq 80\%$ or $< 80\%$ compliant doses on BPA prophylaxis according to standard label requirements could be identified (data to be interpreted with caution due to small sample sizes).</p> <p>Due to the short half-life of bypassing agents, no carryover effect is assumed after its discontinuation.</p> <p>Only the first five emicizumab doses had to be administered under supervision to ensure safety and injection technique proficiency. Similar to BPA prophylaxis, self-administration at home was allowed for all subsequent emicizumab doses.</p>		

Paediatric health-related outcomes results

HAVEN 2 health-related outcomes

In HAVEN 2, HRQoL for patients aged ≥ 8 to < 12 years was evaluated at week 25 based on the Haemo-QoL-SF questionnaire for children (see Table 14). The Haemo-QoL-SF is a valid and reliable measure of HRQoL. HRQoL for patients aged < 12 years was also evaluated at week 25 based on the Adapted InhibQoL with Aspects of Caregiver Burden questionnaire completed by caregivers (see Table 14). The Adapted InhibQoL is a valid and reliable measure of HRQoL.

Table 14 HAVEN 2: Change from baseline to week 25 in the Physical Health score of patients (< 12 years of age) following treatment with Hemlibra prophylaxis as reported by patients and caregivers

	Haemo-QoL-SF
Physical health score (range 0 to 100)^a	
Mean baseline score (95% CI) (n = 18)	29.5 (16.4 – 42.7)
Mean change from baseline (95% CI) (n = 15)	-21.7 (-37.1 - -6.3)
Adapted InhibQoL with aspects of caregiver burden	
Physical health score (range 0 to 100)^a	
Mean baseline score (95% CI) (n = 54)	37.2 (31.5 – 42.8)
Mean change from baseline (95% CI) (n = 43)	-32.4 (-38.6 - -26.2)
^a Lower scores (negative change scores) are reflective of better functioning. Analyses are based on data from individuals who provided responses at both baseline and Week 25 assessments.	

There is limited experience with bypassing agent or FVIII use during surgeries and procedures. Bypassing agent or FVIII use during surgeries and procedures was determined by the investigator.

In the event of breakthrough bleeding, patients receiving emicizumab prophylaxis should be managed with available therapies. For bypassing agent guidance refer to section 4.4.

Immunogenicity

As with all therapeutic proteins, there is the potential for an immune response in patients treated with emicizumab. A total of 739 patients were tested for anti-emicizumab antibodies in the pooled clinical studies. Thirty-six patients (4.9%) tested positive for anti-emicizumab antibodies. In 19 patients (2.6%), anti-emicizumab antibodies were neutralising *in vitro*. Of these 19 patients, the neutralising anti-emicizumab antibodies did not have a clinically meaningful impact on the pharmacokinetics or efficacy of Hemlibra in 15 patients, while decreased emicizumab plasma concentrations were observed in four patients (0.5%). One patient (0.1%) with neutralising anti-emicizumab antibodies and decreased emicizumab plasma concentrations experienced loss of efficacy after five weeks of treatment and discontinued Hemlibra. Overall, the safety profile of Hemlibra was similar between those patients with anti-emicizumab antibodies (including neutralising antibodies) and those without (see sections 4.4 and 4.8).

Elderly population

Use of Hemlibra in patients aged 65 and over with haemophilia A is supported by studies HAVEN 1, HAVEN 3, HAVEN 4 and HAVEN 6. Based on limited data, there is no evidence to suggest a difference in efficacy or safety in patients aged 65 years or above.

5.2 Pharmacokinetic properties

The pharmacokinetics of emicizumab was determined via non-compartmental analysis in healthy subjects and using a population pharmacokinetic analysis on a database composed of 389 patients with haemophilia A.

Absorption

Following subcutaneous administration in haemophilia A patients, the absorption half-life was 1.6 days.

Following multiple subcutaneous administrations of 3 mg/kg once weekly for the first 4 weeks in haemophilia A patients, mean (\pm SD) trough plasma concentrations of emicizumab achieved 52.6 ± 13.6 μ g/mL at Week 5.

The predicted mean (\pm SD) C_{trough} , and C_{max} and ratios of C_{max}/C_{trough} at steady- state for the recommended maintenance doses of 1.5 mg/kg once weekly, 3 mg/kg every two weeks or 6 mg/kg every four weeks are shown in Table 15 .

Table 15 Mean (\pm SD) steady-state emicizumab concentrations

Parameters	Maintenance dose		
	1.5 mg/kg QW	3 mg/kg Q2W	6 mg/kg Q4W
$C_{max, ss}$ (μ g/mL)	54.9 \pm 15.9	58.1 \pm 16.5	66.8 \pm 17.7
$C_{avg, ss}$ (μ g/mL)	53.5 \pm 15.7	53.5 \pm 15.7	53.5 \pm 15.7
$C_{trough, ss}$ (μ g/mL)	51.1 \pm 15.3	46.7 \pm 16.9	38.3 \pm 14.3
C_{max}/C_{trough} ratio	1.08 \pm 0.03	1.26 \pm 0.12	1.85 \pm 0.46

$C_{avg, ss}$ = average concentration at steady state; $C_{max, ss}$ = maximum plasma concentration at steady state; $C_{trough, ss}$ = trough concentration at steady state; QW = once weekly; Q2W = every two weeks; Q4W = every four weeks. Pharmacokinetic parameters derived from the population PK model.

Similar PK profiles were observed following once weekly dosing (3 mg/kg/week for 4 weeks followed by 1.5 mg/kg/week) in adults/adolescents (≥ 12 years) and children (< 12 years) (see Figure 1).

Figure 1: Mean (\pm 95% CI) plasma emicizumab concentration versus time profiles for patients ≥ 12 years (studies HAVEN 1 and HAVEN 3) compared with patients < 12 years (study HAVEN 2)

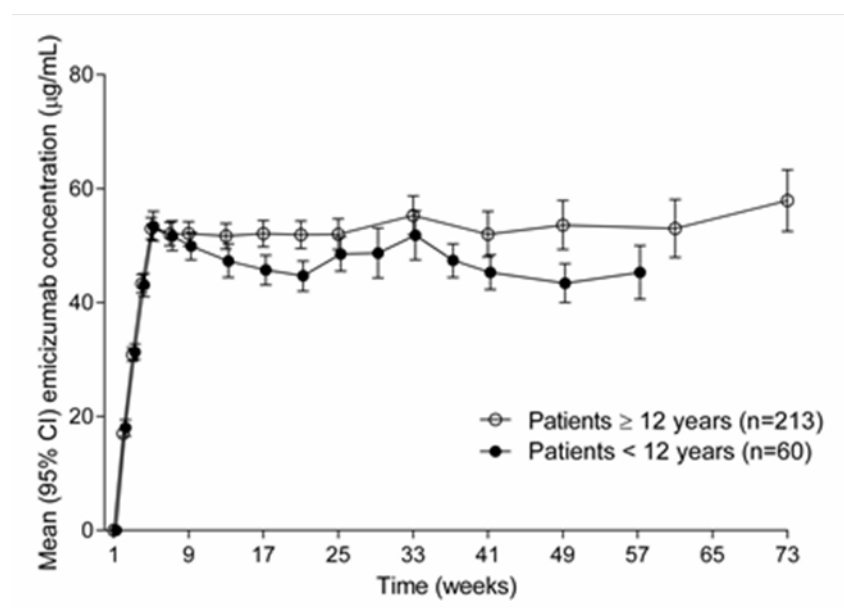

In healthy subjects, the absolute bioavailability following subcutaneous administration of 1 mg/kg was between 80.4% and 93.1% depending on the injection site. Similar pharmacokinetic profiles were observed following subcutaneous administration in the abdomen, upper arm, and thigh. Emicizumab can be administered interchangeably at these anatomical sites (see section 4.2).

Distribution

Following a single intravenous dose of 0.25 mg/kg emicizumab in healthy subjects, the volume of distribution at steady state was 106 mL/kg (i.e. 7.4 L for a 70-kg adult).

The apparent volume of distribution (V/F), estimated from the population PK analysis, in haemophilia A patients following multiple subcutaneous doses of emicizumab was 10.4 L.

Metabolism

The metabolism of emicizumab has not been studied. IgG antibodies are mainly catabolised by lysosomal proteolysis and then eliminated from or reused by the body.

Elimination

Following intravenous administration of 0.25 mg/kg in healthy subjects, the total clearance of emicizumab was 3.26 mL/kg/day (i.e. 0.228 L/d for a 70-kg adult) and the mean terminal half-life was 26.7 days.

Following single subcutaneous injection in healthy subjects, the elimination half-life was approximately 4 to 5 weeks.

Following multiple subcutaneous injections in haemophilia A patients, the apparent clearance was 0.272 L/day and the elimination apparent half-life was 26.8 days.

Dose linearity

Emicizumab exhibited dose-proportional pharmacokinetics in patients with haemophilia A after the first dose of Hemlibra over a dose range from 0.3 to 6 mg/kg. The exposure ($C_{avg, ss}$) of multiple doses is comparable between 1.5 mg/kg every week, 3mg/kg every 2 weeks and 6mg/kg dose every 4 weeks.

Special populations

Paediatric

The effect of age on the pharmacokinetics of emicizumab was assessed in a population pharmacokinetic analysis which included 5 infants (≥ 1 month to < 2 years), 55 children (less than 12 years) and 50 adolescents (12 to < 18 years) with haemophilia A. Age did not affect the pharmacokinetics of emicizumab in paediatric patients.

Elderly

The effect of age on the pharmacokinetics of emicizumab was assessed in a population pharmacokinetic analysis which included thirteen subjects aged 65 years and older (no subjects were older than 77 years of age). Relative bioavailability decreased with older age, but no clinically important differences were observed in the pharmacokinetics of emicizumab between subjects < 65 years and subjects ≥ 65 years.

Race

Population pharmacokinetics analyses in patients with haemophilia A showed that race did not affect the pharmacokinetics of emicizumab. No dose adjustment is required for this demographic factor.

Gender

Data in female patients are too limited for conclusion.

Renal impairment

No dedicated studies of the effect of renal impairment on the pharmacokinetics of emicizumab have been conducted.

Most of the patients with haemophilia A in the population pharmacokinetic analysis had normal renal function (N = 332; creatinine clearance [CLcr] \geq 90 mL/min) or mild renal impairment (N = 27; CLcr of 60-89 mL/min). Mild renal impairment did not affect the pharmacokinetics of emicizumab. There are limited data available on the use of Hemlibra in patients with moderate renal impairment (only 2 patients with CLcr of 30-59 mL/min) and no data in patients with severe renal impairment. The impact of moderate and severe renal impairment on the pharmacokinetics of emicizumab cannot be concluded.

Emicizumab is a monoclonal antibody and is cleared via catabolism rather than renal excretion and a change in dose is not expected to be required for patients with renal impairment.

Hepatic impairment

No dedicated studies on the effect of hepatic impairment on the pharmacokinetics of emicizumab have been conducted. Most of the patients with haemophilia A in the population pharmacokinetic analysis had normal hepatic function (bilirubin and AST \leq ULN, N = 300) or mild hepatic impairment (bilirubin \leq ULN and AST $>$ ULN or bilirubin from 1.0 to 1.5 \times ULN and any AST, N = 51). Only 6 patients had moderate hepatic impairment (1.5 \times ULN $<$ bilirubin \leq 3 \times ULN and any AST). Mild hepatic impairment did not affect the pharmacokinetics of emicizumab (see section 4.2). The safety and efficacy of emicizumab have not been specifically tested in patients with hepatic impairment. Patients with mild and moderate hepatic impairment were included in clinical studies. No data are available on the use of Hemlibra in patients with severe hepatic impairment.

Emicizumab is a monoclonal antibody and cleared via catabolism rather than hepatic metabolism and a change in dose is not expected to be required for patients with hepatic impairment.

Other special populations

Modelling shows that less frequent dosing in patients with hypoalbuminemia and low body weight for their age results in lower emicizumab exposures; simulations indicate that these patients would still benefit from clinically meaningful bleed control. No patients with such characteristics were enrolled in clinical studies.

5.3 Preclinical safety data

Preclinical data reveal no special hazards for humans based on studies of acute and repeated dose toxicity, including safety pharmacology endpoints and endpoints for reproductive toxicity.

Fertility

Emicizumab did not cause any changes in the reproductive organs of male or female cynomolgus monkeys up to the highest tested dose of 30 mg/kg/week (equivalent to 11 times the human exposure at the highest dose of 3 mg/kg/week, based on AUC).

Teratogenicity

No data are available with respect to potential side effects of emicizumab on embryo-foetal development.

Injection site reactions

Reversible haemorrhage, perivascular mononuclear cell infiltration, degeneration/necrosis of subcutis and swelling of endothelium in the subcutis was noted in animals after subcutaneous injection.

6. PHARMACEUTICAL PARTICULARS

6.1 List of excipients

L-Arginine
L-Histidine
L-Aspartic acid
Poloxamer 188
Water for injections

6.2 Incompatibilities

No incompatibilities between Hemlibra and polypropylene or polycarbonate syringes and stainless steel needles have been observed.

In the absence of compatibility studies, this medicinal product must not be mixed with other medicinal products.

6.3 Shelf life

Unopened vial

Hemlibra 30 mg/mL solution for injection

2 years.

Hemlibra 150 mg/mL solution for injection

2 years.

Once removed from the refrigerator, unopened vials can be kept at room temperature (below 30°C) for up to 7 days.

After storage at room temperature, unopened vials may be returned to the refrigerator. If stored out of and then returned to refrigeration, the total combined time out of refrigeration should not exceed 7 days. The vials should never be exposed to temperatures above 30 °C. Vials that have been kept at room temperature for more than 7 days or exposed to temperatures above 30 °C should be discarded.

Pierced vial and filled syringe

From a microbiological point of view, once transferred from the vial to the syringe, the medicinal product should be used immediately. If not used immediately, in-use storage times and conditions are the responsibility of the user.

6.4 Special precautions for storage

Store in a refrigerator (2°C - 8°C).

Do not freeze.

Keep the vial in the outer carton in order to protect from light.

For storage conditions after first opening of the medicinal product, see section 6.3.

6.5 Nature and contents of container

Hemlibra 30 mg/mL solution for injection

3 mL clear glass type I vial with butyl rubber stopper laminated with a fluoro-resin film and crimped with an aluminium cap fitted with a grey plastic flip-off disk. Each vial contains 12 mg emicizumab in 0.4 mL of solution for injection. Each carton contains one vial.

3 mL clear glass type I vial with butyl rubber stopper laminated with a fluoro-resin film and crimped with an aluminium cap fitted with a sky blue plastic flip-off disk. Each vial contains 30 mg emicizumab in 1 mL of solution for injection. Each carton contains one vial.

Hemlibra 150 mg/mL solution for injection

3 mL clear glass type I vial with butyl rubber stopper laminated with a fluoro-resin film and crimped with an aluminium cap fitted with a purple plastic flip-off disk. Each vial contains 60 mg emicizumab in 0.4 mL of solution for injection. Each carton contains one vial.

3 mL clear glass type I vial with butyl rubber stopper laminated with a fluoro-resin film and crimped with an aluminium cap fitted with a turquoise plastic flip-off disk. Each vial contains 105 mg emicizumab in 0.7 mL of solution for injection. Each carton contains one vial.

3 mL clear glass type I vial with butyl rubber stopper laminated with a fluoro-resin film and crimped with an aluminium cap fitted with a brown plastic flip-off disk. Each vial contains 150 mg emicizumab in 1 mL of solution for injection. Each carton contains one vial.

3 mL clear glass type I vial with butyl rubber stopper laminated with a fluoro-resin film and crimped with an aluminium cap fitted with a yellow plastic flip-off disk. Each vial contains 300 mg emicizumab in 2 mL of solution for injection. Each carton contains one vial.

Not all pack sizes may be marketed.

6.6 Special precautions for disposal and other handling

Hemlibra solution is a sterile, preservative-free, and ready to use solution for subcutaneous injection that does not need to be diluted.

Hemlibra should be inspected visually to ensure there is no particulate matter or discolouration prior to administration. Hemlibra is a colourless to slightly yellow solution. The solution should be discarded if particulate matter is visible or product is discoloured.

Do not shake.

Hemlibra solution for injection vials are for single-use only.

A syringe, a transfer needle with filter or a vial adapter with filter, and an injection needle are needed to withdraw Hemlibra solution from the vial and inject it subcutaneously.

Please see below recommended features:

A 1 mL syringe should be used for an injection up to 1 mL of Hemlibra solution, whereas a 2 to 3 mL syringe should be used for an injection greater than 1 mL and up to 2 mL.

Refer to the Hemlibra “Instructions for Use” for handling instructions when combining vials in a syringe. Different Hemlibra vial concentrations (30 mg/mL and 150 mg/mL) should not be combined in a single injection to administer the prescribed dose.

1 mL syringe

Criteria: Transparent polypropylene or polycarbonate syringe with Luer-lock tip, graduation 0.01 mL.

2 to 3 mL syringe

Criteria: Transparent polypropylene or polycarbonate syringe with Luer-lock tip, graduation 0.1 mL.

Transfer needle with filter

Criteria for transfer needle with filter: Stainless steel with Luer-lock connection, gauge 18 G, length 35 mm (1½”), containing a 5 micrometre filter and preferably with semi-blunted tip.

Vial adapter with filter

Criteria for vial adapter with filter: Polypropylene with Luer-lock connection, integrating a 5 micrometre filter, fitting 15 mm vial neck diameter.

Injection needle

Criteria: Stainless steel with Luer-lock connection, gauge 26 G (acceptable range: 25-27 gauge), length preferably 9 mm (3/8”) or maximally 13 mm (½”), preferably including needle safety feature.

Please see section 4.2 and package leaflet (section 7 Instructions for Use), for additional information on administration.

Any unused medicinal product or waste material should be disposed of in accordance with local requirements.

7. MARKETING AUTHORISATION HOLDER

Roche Registration GmbH
Emil-Barell-Strasse 1
79639 Grenzach-Wyhlen
Germany

8. MARKETING AUTHORISATION NUMBER(S)

Hemlibra 30 mg/mL solution for injection

EU/1/18/1271/006 (12 mg/0.4 mL)

EU/1/18/1271/001 (30 mg/1 mL)

Hemlibra 150 mg/mL solution for injection

EU/1/18/1271/002 (60 mg/0.4 mL)

EU/1/18/1271/003 (105 mg/0.7 mL)

EU/1/18/1271/004 (150 mg/1 mL)

EU/1/18/1271/005 (300 mg/2 mL)

9. DATE OF FIRST AUTHORISATION/RENEWAL OF THE AUTHORISATION

Date of first authorisation: 23 February 2018

Date of latest renewal: 15 September 2022

10. DATE OF REVISION OF THE TEXT

Detailed information on this medicinal product is available on the website of the European Medicines Agency <http://www.ema.europa.eu>.

ANNEX II

- A. MANUFACTURERS OF THE BIOLOGICAL ACTIVE SUBSTANCE AND MANUFACTURER RESPONSIBLE FOR BATCH RELEASE**
- B. CONDITIONS OR RESTRICTIONS REGARDING SUPPLY AND USE**
- C. OTHER CONDITIONS AND REQUIREMENTS OF THE MARKETING AUTHORISATION**
- D. CONDITIONS OR RESTRICTIONS WITH REGARD TO THE SAFE AND EFFECTIVE USE OF THE MEDICINAL PRODUCT**

A. MANUFACTURERS OF THE BIOLOGICAL ACTIVE SUBSTANCE AND MANUFACTURER RESPONSIBLE FOR BATCH RELEASE

Name and address of the manufacturers of the biological active substance

Chugai Pharma Manufacturing Co., Ltd.
5-1, Ukima 5-Chome
Kita-Ku, Tokyo
115-8543
Japan

F. Hoffmann-La Roche Ltd.
Grenzacherstrasse 124
4070 Basel
Switzerland

Name and address of the manufacturer responsible for batch release

Roche Pharma AG
Emil-Barell-Strasse 1
79639 Grenzach-Wyhlen
Germany

B. CONDITIONS OR RESTRICTIONS REGARDING SUPPLY AND USE

Medicinal product subject to restricted medical prescription (see Annex I: Summary of Product Characteristics, section 4.2).

C. OTHER CONDITIONS AND REQUIREMENTS OF THE MARKETING AUTHORISATION

● **Periodic safety update reports (PSURs)**

The requirements for submission of PSURs for this medicinal product are set out in the list of Union reference dates (EURD list) provided for under Article 107c(7) of Directive 2001/83/EC and any subsequent updates published on the European medicines web-portal.

D. CONDITIONS OR RESTRICTIONS WITH REGARD TO THE SAFE AND EFFECTIVE USE OF THE MEDICINAL PRODUCT

● **Risk management plan (RMP)**

The marketing authorisation holder (MAH) shall perform the required pharmacovigilance activities and interventions detailed in the agreed RMP presented in Module 1.8.2 of the marketing authorisation and any agreed subsequent updates of the RMP.

An updated RMP should be submitted:

- At the request of the European Medicines Agency;
- Whenever the risk management system is modified, especially as the result of new information being received that may lead to a significant change to the benefit/risk profile or as the result of

an important (pharmacovigilance or risk minimisation) milestone being reached.

- **Additional risk minimisation measures**

Prior to launch of Hemlibra in each Member State the Marketing Authorisation Holder (MAH) must agree about the content and format of the educational programme, including communication media, distribution modalities, and any other aspects of the programme, with the National Competent Authority.

The educational programme is aimed at increasing communication and medical and patient education around the important identified risks of thromboembolic events and thrombotic microangiopathy (TMA) associated with the concomitant use of emicizumab and activated prothrombin complex concentrate (aPCC), and the important potential risk of life-threatening bleeding due to misinterpretation of the standard coagulation tests (unreliable in patients treated with emicizumab) and provide information on how to manage them.

The MAH shall ensure that in each Member State where Hemlibra is marketed, all healthcare professionals, patients/carers who are expected to prescribe, dispense or use Hemlibra, and laboratory professionals, have access to/are provided with the following educational package:

- Physician educational material
- Patient/Carer educational material
- Laboratory professionals educational material
- Patient Card

The physician educational material should contain:

- The Summary of Product Characteristics
- Guide for healthcare professionals

- **The guide for healthcare professionals** shall contain the following key elements:

- Brief introduction to emicizumab (chemical class, mode of action, pharmacodynamics and indication)
- Relevant information (e.g. seriousness, severity, frequency, time to onset, reversibility as applicable) of the following safety concerns associated with the use of Hemlibra:
 - thromboembolic events associated with the concomitant use of emicizumab and aPCC,
 - TMA associated with the concomitant use of emicizumab and aPCC
 - life-threatening bleeding due to misinterpretation of the standard coagulation tests (unreliable in patients treated with emicizumab)
- Guidance on the use of bypassing agents concomitantly with emicizumab, including the following information:
 - Treatment with prophylactic bypassing agents should be discontinued the day before starting emicizumab therapy;
 - Physicians should discuss with all patients and/or caregivers the exact dose and schedule of bypassing agents to use, if required while receiving emicizumab prophylaxis;
 - Emicizumab increases the patient's coagulation potential and the dose and duration of treatment with bypassing agents may require adjustment depending on the location and extent of bleeding and on the patient's clinical conditions;
 - For all coagulation agents (aPCC, rFVIIa, FVIII, etc.), consideration should be given to verifying bleeds prior to repeated dosing;
 - Use of aPCC should be avoided unless no other treatment options/alternatives are

- available and aPCC dosing recommendations in case aPCC is the only option.
- Treating physicians must carefully weigh the risk of TMA and thromboembolism against the risk of bleeding when considering aPCC treatment.
- Information on emicizumab's interference with certain laboratory coagulation tests which will affect their reliability in the emicizumab setting and warning that these tests should not be used to monitor for emicizumab activity, determine need for factor replacement dosing, or measure FVIII inhibitors.
- Information on assays and methods not affected by emicizumab that may be used to assess coagulation parameters during treatment, with specific considerations for FVIII chromogenic activity assays;
- Listing of laboratory tests unaffected by emicizumab;
- Reminder that all patients receiving treatment with emicizumab should be given a Patient Card and reminded to carry it at all times and show it to any healthcare professionals who may treat them and to laboratory professionals that will perform their coagulation testing;
- Reminder to report any adverse events associated with the use of emicizumab.

The patient/carer educational material should contain:

- The package leaflet
- Guide for patients/carers
- **The guide for patients/carers** shall contain the following key messages:
 - What is emicizumab, how emicizumab has been tested, and how to use emicizumab;
 - Warning on the risks associated with the concomitant use of bypassing agents and Hemlibra and to discuss with their doctor if they are receiving aPCC when being prescribed or while receiving Hemlibra;
 - Description of the signs and symptoms of the following safety concerns and reminder of the importance of immediately stopping using Hemlibra and aPCC and notifying their treating physician if symptoms occur :
 - Destruction of red blood cells (TMA)
 - Blood clots (thromboembolism)
 - Information that they should be given a Patient Card and reminder to carry it at all times and to show it to any healthcare professionals who may treat them;
 - Information on emicizumab's interference with certain laboratory coagulation tests which will affect their reliability and on the importance to show the Patient Card to any healthcare professionals who may treat them and to laboratory professionals that will perform their coagulation testing;
 - Reminder to report any adverse events to their treating doctor.

The laboratory professional educational material should contain:

- The Summary of Product Characteristics
- Guide for Laboratory Professionals
- **The guide for laboratory professionals** shall contain the following key messages:
 - Chemical class, mode of action, pharmacodynamics and indication for emicizumab
 - Information on emicizumab's interference with certain laboratory coagulation tests which will affect their reliability and not accurately reflect the patient's underlying hemostatic status during emicizumab prophylaxis. Warning that these tests should not be used to monitor for emicizumab activity, determine need for factor replacement dosing, or measure FVIII inhibitors;
 - Information on assays and methods not affected by emicizumab and that may be used to assess coagulation parameters during treatment, with specific considerations for FVIII chromogenic activity assays;
 - Listing of laboratory tests unaffected by emicizumab;

- Recommendation that the laboratory director contact the patient's treating physician to discuss any abnormal test results.

The Patient Card shall contain the following key messages:

- Instructions for patients to carry the card at any time, including in conditions of emergency and to present the card at visits to doctors, hospital clinics, carers, laboratory professionals or pharmacists to inform on emicizumab treatment and risks;
- Information on serious, life-threatening thromboembolic events or TMA events that have been observed with the concomitant use of emicizumab with aPCC in patients on emicizumab prophylaxis;
- Guidance on the use of bypassing agents concomitantly with emicizumab and on the dosing recommendations for patients requiring treatment with bypassing agents in the perioperative setting;
- Warning on emicizumab's interference with certain laboratory coagulation tests which will affect their reliability and information that single-factor assays utilizing chromogenic or immuno-based methods are not affected by emicizumab and may be used to assess coagulation parameters during treatment, with specific consideration for factor VIII chromogenic activity assays;
- Contact details of the patient's emicizumab prescriber.

ANNEX III
LABELLING AND PACKAGE LEAFLET

A. LABELLING

PARTICULARS TO APPEAR ON THE OUTER PACKAGING

OUTER CARTON

1. NAME OF THE MEDICINAL PRODUCT

Hemlibra 30 mg/mL solution for injection
emicizumab

2. STATEMENT OF ACTIVE SUBSTANCE(S)

Each vial of 0.4 mL contains 12 mg of emicizumab at a concentration of 30 mg/mL.

3. LIST OF EXCIPIENTS

Excipients: L-Arginine, L-Histidine, L-Aspartic acid, Poloxamer 188, water for injections.

4. PHARMACEUTICAL FORM AND CONTENTS

Solution for injection

1 vial
12 mg/0.4 mL

5. METHOD AND ROUTE(S) OF ADMINISTRATION

For subcutaneous use
Read the package leaflet before use
Do not shake

6. SPECIAL WARNING THAT THE MEDICINAL PRODUCT MUST BE STORED OUT OF THE SIGHT AND REACH OF CHILDREN

Keep out of the sight and reach of children

7. OTHER SPECIAL WARNING(S), IF NECESSARY

8. EXPIRY DATE

EXP

9. SPECIAL STORAGE CONDITIONS

Store in a refrigerator
Do not freeze
Keep the vial in the outer carton in order to protect from light

10. SPECIAL PRECAUTIONS FOR DISPOSAL OF UNUSED MEDICINAL PRODUCTS OR WASTE MATERIALS DERIVED FROM SUCH MEDICINAL PRODUCTS, IF APPROPRIATE

11. NAME AND ADDRESS OF THE MARKETING AUTHORISATION HOLDER

Roche Registration GmbH
Emil-Barell-Strasse 1
79639 Grenzach-Wyhlen
Germany

12. MARKETING AUTHORISATION NUMBER(S)

EU/1/18/1271/006

13. BATCH NUMBER

Lot

14. GENERAL CLASSIFICATION FOR SUPPLY

15. INSTRUCTIONS ON USE

16. INFORMATION IN BRAILLE

hemlibra 12 mg

17. UNIQUE IDENTIFIER – 2D BARCODE

2D barcode carrying the unique identifier included.

18. UNIQUE IDENTIFIER - HUMAN READABLE DATA

PC
SN
NN

MINIMUM PARTICULARS TO APPEAR ON SMALL IMMEDIATE PACKAGING UNITS

VIAL

1. NAME OF THE MEDICINAL PRODUCT AND ROUTE(S) OF ADMINISTRATION

Hemlibra 30 mg/mL solution for injection
emicizumab
For subcutaneous use

2. METHOD OF ADMINISTRATION

Do not shake

3. EXPIRY DATE

EXP

4. BATCH NUMBER

Lot

5. CONTENTS BY WEIGHT, BY VOLUME OR BY UNIT

12 mg/0.4 mL

6. OTHER

PARTICULARS TO APPEAR ON THE OUTER PACKAGING

OUTER CARTON

1. NAME OF THE MEDICINAL PRODUCT

Hemlibra 30 mg/mL solution for injection
emicizumab

2. STATEMENT OF ACTIVE SUBSTANCE(S)

Each vial of 1 mL contains 30 mg of emicizumab at a concentration of 30 mg/mL.

3. LIST OF EXCIPIENTS

Excipients: L-Arginine, L-Histidine, L-Aspartic acid, Poloxamer 188, water for injections.

4. PHARMACEUTICAL FORM AND CONTENTS

Solution for injection

1 vial
30 mg/1 mL

5. METHOD AND ROUTE(S) OF ADMINISTRATION

For subcutaneous use
Read the package leaflet before use
Do not shake

6. SPECIAL WARNING THAT THE MEDICINAL PRODUCT MUST BE STORED OUT OF THE SIGHT AND REACH OF CHILDREN

Keep out of the sight and reach of children

7. OTHER SPECIAL WARNING(S), IF NECESSARY

8. EXPIRY DATE

EXP

9. SPECIAL STORAGE CONDITIONS

Store in a refrigerator
Do not freeze
Keep the vial in the outer carton in order to protect from light

10. SPECIAL PRECAUTIONS FOR DISPOSAL OF UNUSED MEDICINAL PRODUCTS OR WASTE MATERIALS DERIVED FROM SUCH MEDICINAL PRODUCTS, IF APPROPRIATE

11. NAME AND ADDRESS OF THE MARKETING AUTHORISATION HOLDER

Roche Registration GmbH
Emil-Barell-Strasse 1
79639 Grenzach-Wyhlen
Germany

12. MARKETING AUTHORISATION NUMBER(S)

EU/1/18/1271/001

13. BATCH NUMBER

Lot

14. GENERAL CLASSIFICATION FOR SUPPLY

15. INSTRUCTIONS ON USE

16. INFORMATION IN BRAILLE

hemlibra 30 mg

17. UNIQUE IDENTIFIER – 2D BARCODE

2D barcode carrying the unique identifier included.

18. UNIQUE IDENTIFIER - HUMAN READABLE DATA

PC
SN
NN

MINIMUM PARTICULARS TO APPEAR ON SMALL IMMEDIATE PACKAGING UNITS

VIAL

1. NAME OF THE MEDICINAL PRODUCT AND ROUTE(S) OF ADMINISTRATION

Hemlibra 30 mg/mL solution for injection
emicizumab
For subcutaneous use

2. METHOD OF ADMINISTRATION

Do not shake

3. EXPIRY DATE

EXP

4. BATCH NUMBER

Lot

5. CONTENTS BY WEIGHT, BY VOLUME OR BY UNIT

30 mg/1 mL

6. OTHER

PARTICULARS TO APPEAR ON THE OUTER PACKAGING

OUTER CARTON

1. NAME OF THE MEDICINAL PRODUCT

Hemlibra 150 mg/mL solution for injection
emicizumab

2. STATEMENT OF ACTIVE SUBSTANCE(S)

Each vial of 0.4 mL contains 60 mg of emicizumab at a concentration of 150 mg/mL.

3. LIST OF EXCIPIENTS

Excipients: L-Arginine, L-Histidine, L-Aspartic acid, Poloxamer 188, water for injections.

4. PHARMACEUTICAL FORM AND CONTENTS

Solution for injection

1 vial
60 mg/0.4 mL

5. METHOD AND ROUTE(S) OF ADMINISTRATION

For subcutaneous use
Read the package leaflet before use
Do not shake

6. SPECIAL WARNING THAT THE MEDICINAL PRODUCT MUST BE STORED OUT OF THE SIGHT AND REACH OF CHILDREN

Keep out of the sight and reach of children

7. OTHER SPECIAL WARNING(S), IF NECESSARY

8. EXPIRY DATE

EXP

9. SPECIAL STORAGE CONDITIONS

Store in a refrigerator
Do not freeze
Keep the vial in the outer carton in order to protect from light

10. SPECIAL PRECAUTIONS FOR DISPOSAL OF UNUSED MEDICINAL PRODUCTS OR WASTE MATERIALS DERIVED FROM SUCH MEDICINAL PRODUCTS, IF APPROPRIATE

11. NAME AND ADDRESS OF THE MARKETING AUTHORISATION HOLDER

Roche Registration GmbH
Emil-Barell-Strasse 1
79639 Grenzach-Wyhlen
Germany

12. MARKETING AUTHORISATION NUMBER(S)

EU/1/18/1271/002

13. BATCH NUMBER

Lot

14. GENERAL CLASSIFICATION FOR SUPPLY

15. INSTRUCTIONS ON USE

16. INFORMATION IN BRAILLE

hemlibra 60 mg

17. UNIQUE IDENTIFIER – 2D BARCODE

2D barcode carrying the unique identifier included.

18. UNIQUE IDENTIFIER - HUMAN READABLE DATA

PC
SN
NN

MINIMUM PARTICULARS TO APPEAR ON SMALL IMMEDIATE PACKAGING UNITS

VIAL

1. NAME OF THE MEDICINAL PRODUCT AND ROUTE(S) OF ADMINISTRATION

Hemlibra 150 mg/mL solution for injection
emicizumab
For subcutaneous use

2. METHOD OF ADMINISTRATION

Do not shake

3. EXPIRY DATE

EXP

4. BATCH NUMBER

Lot

5. CONTENTS BY WEIGHT, BY VOLUME OR BY UNIT

60 mg/0.4 mL

6. OTHER

PARTICULARS TO APPEAR ON THE OUTER PACKAGING

OUTER CARTON

1. NAME OF THE MEDICINAL PRODUCT

Hemlibra 150 mg/mL solution for injection
emicizumab

2. STATEMENT OF ACTIVE SUBSTANCE(S)

Each vial of 0.7 mL contains 105 mg of emicizumab at a concentration of 150 mg/mL.

3. LIST OF EXCIPIENTS

Excipients: L-Arginine, L-Histidine, L-Aspartic acid, Poloxamer 188, water for injections.

4. PHARMACEUTICAL FORM AND CONTENTS

Solution for injection

1 vial
105 mg/0.7 mL

5. METHOD AND ROUTE(S) OF ADMINISTRATION

For subcutaneous use
Read the package leaflet before use
Do not shake

6. SPECIAL WARNING THAT THE MEDICINAL PRODUCT MUST BE STORED OUT OF THE SIGHT AND REACH OF CHILDREN

Keep out of the sight and reach of children

7. OTHER SPECIAL WARNING(S), IF NECESSARY

8. EXPIRY DATE

EXP

9. SPECIAL STORAGE CONDITIONS

Store in a refrigerator
Do not freeze
Keep the vial in the outer carton in order to protect from light

10. SPECIAL PRECAUTIONS FOR DISPOSAL OF UNUSED MEDICINAL PRODUCTS OR WASTE MATERIALS DERIVED FROM SUCH MEDICINAL PRODUCTS, IF APPROPRIATE**11. NAME AND ADDRESS OF THE MARKETING AUTHORISATION HOLDER**

Roche Registration GmbH
Emil-Barell-Strasse 1
79639 Grenzach-Wyhlen
Germany

12. MARKETING AUTHORISATION NUMBER(S)

EU/1/18/1271/003

13. BATCH NUMBER

Lot

14. GENERAL CLASSIFICATION FOR SUPPLY**15. INSTRUCTIONS ON USE****16. INFORMATION IN BRAILLE**

hemlibra 105 mg

17. UNIQUE IDENTIFIER – 2D BARCODE

2D barcode carrying the unique identifier included.

18. UNIQUE IDENTIFIER - HUMAN READABLE DATA

PC
SN
NN

MINIMUM PARTICULARS TO APPEAR ON SMALL IMMEDIATE PACKAGING UNITS

VIAL

1. NAME OF THE MEDICINAL PRODUCT AND ROUTE(S) OF ADMINISTRATION

Hemlibra 150 mg/mL solution for injection
emicizumab
For subcutaneous use

2. METHOD OF ADMINISTRATION

Do not shake

3. EXPIRY DATE

EXP

4. BATCH NUMBER

Lot

5. CONTENTS BY WEIGHT, BY VOLUME OR BY UNIT

105 mg/0.7 mL

6. OTHER

PARTICULARS TO APPEAR ON THE OUTER PACKAGING

OUTER CARTON

1. NAME OF THE MEDICINAL PRODUCT

Hemlibra 150 mg/mL solution for injection
emicizumab

2. STATEMENT OF ACTIVE SUBSTANCE(S)

Each vial of 1 mL contains 150 mg of emicizumab at a concentration of 150 mg/mL.

3. LIST OF EXCIPIENTS

Excipients: L-Arginine, L-Histidine, L-Aspartic acid, Poloxamer 188, water for injections.

4. PHARMACEUTICAL FORM AND CONTENTS

Solution for injection

1 vial
150 mg/1 mL

5. METHOD AND ROUTE(S) OF ADMINISTRATION

For subcutaneous use
Read the package leaflet before use
Do not shake

6. SPECIAL WARNING THAT THE MEDICINAL PRODUCT MUST BE STORED OUT OF THE SIGHT AND REACH OF CHILDREN

Keep out of the sight and reach of children

7. OTHER SPECIAL WARNING(S), IF NECESSARY

8. EXPIRY DATE

EXP

9. SPECIAL STORAGE CONDITIONS

Store in a refrigerator
Do not freeze
Keep the vial in the outer carton in order to protect from light

10. SPECIAL PRECAUTIONS FOR DISPOSAL OF UNUSED MEDICINAL PRODUCTS OR WASTE MATERIALS DERIVED FROM SUCH MEDICINAL PRODUCTS, IF APPROPRIATE

11. NAME AND ADDRESS OF THE MARKETING AUTHORISATION HOLDER

Roche Registration GmbH
Emil-Barell-Strasse 1
79639 Grenzach-Wyhlen
Germany

12. MARKETING AUTHORISATION NUMBER(S)

EU/1/18/1271/004

13. BATCH NUMBER

Lot

14. GENERAL CLASSIFICATION FOR SUPPLY

15. INSTRUCTIONS ON USE

16. INFORMATION IN BRAILLE

hemlibra 150 mg

17. UNIQUE IDENTIFIER – 2D BARCODE

2D barcode carrying the unique identifier included.

18. UNIQUE IDENTIFIER - HUMAN READABLE DATA

PC
SN
NN

MINIMUM PARTICULARS TO APPEAR ON SMALL IMMEDIATE PACKAGING UNITS

VIAL

1. NAME OF THE MEDICINAL PRODUCT AND ROUTE(S) OF ADMINISTRATION

Hemlibra 150 mg/mL solution for injection
emicizumab
For subcutaneous use

2. METHOD OF ADMINISTRATION

Do not shake

3. EXPIRY DATE

EXP

4. BATCH NUMBER

Lot

5. CONTENTS BY WEIGHT, BY VOLUME OR BY UNIT

150 mg/1 mL

6. OTHER

PARTICULARS TO APPEAR ON THE OUTER PACKAGING

OUTER CARTON

1. NAME OF THE MEDICINAL PRODUCT

Hemlibra 150 mg/mL solution for injection
emicizumab

2. STATEMENT OF ACTIVE SUBSTANCE(S)

Each vial of 2 mL contains 300 mg of emicizumab at a concentration of 150 mg/mL.

3. LIST OF EXCIPIENTS

Excipients: L-Arginine, L-Histidine, L-Aspartic acid, Poloxamer 188, water for injections.

4. PHARMACEUTICAL FORM AND CONTENTS

Solution for injection

1 vial
300 mg/2 mL

5. METHOD AND ROUTE(S) OF ADMINISTRATION

For subcutaneous use
Read the package leaflet before use
Do not shake

6. SPECIAL WARNING THAT THE MEDICINAL PRODUCT MUST BE STORED OUT OF THE SIGHT AND REACH OF CHILDREN

Keep out of the sight and reach of children

7. OTHER SPECIAL WARNING(S), IF NECESSARY

8. EXPIRY DATE

EXP

9. SPECIAL STORAGE CONDITIONS

Store in a refrigerator
Do not freeze
Keep the vial in the outer carton in order to protect from light

10. SPECIAL PRECAUTIONS FOR DISPOSAL OF UNUSED MEDICINAL PRODUCTS OR WASTE MATERIALS DERIVED FROM SUCH MEDICINAL PRODUCTS, IF APPROPRIATE

11. NAME AND ADDRESS OF THE MARKETING AUTHORISATION HOLDER

Roche Registration GmbH
Emil-Barell-Strasse 1
79639 Grenzach-Wyhlen
Germany

12. MARKETING AUTHORISATION NUMBER(S)

EU/1/18/1271/005

13. BATCH NUMBER

Lot

14. GENERAL CLASSIFICATION FOR SUPPLY

15. INSTRUCTIONS ON USE

16. INFORMATION IN BRAILLE

hemlibra 300 mg

17. UNIQUE IDENTIFIER – 2D BARCODE

2D barcode carrying the unique identifier included.

18. UNIQUE IDENTIFIER - HUMAN READABLE DATA

PC
SN
NN

MINIMUM PARTICULARS TO APPEAR ON SMALL IMMEDIATE PACKAGING UNITS

VIAL

1. NAME OF THE MEDICINAL PRODUCT AND ROUTE(S) OF ADMINISTRATION

Hemlibra 150 mg/mL solution for injection
emicizumab
For subcutaneous use

2. METHOD OF ADMINISTRATION

Do not shake

3. EXPIRY DATE

EXP

4. BATCH NUMBER

Lot

5. CONTENTS BY WEIGHT, BY VOLUME OR BY UNIT

300 mg/2 mL

6. OTHER

B. PACKAGE LEAFLET

Package leaflet: Information for the user

Hemlibra 30 mg/mL solution for injection emicizumab

Read all of this leaflet carefully before you start using this medicine because it contains important information for you.

- Keep this leaflet. You may need to read it again.
- If you have any further questions, ask your doctor, pharmacist or nurse.
- This medicine has been prescribed for you only. Do not pass it on to others. It may harm them, even if their signs of illness are the same as yours.
- If you get any side effects, talk to your doctor, pharmacist or nurse. This includes any possible side effects not listed in this leaflet. See section 4.

In addition to this leaflet, your doctor will give you a patient card, which contains important safety information that you need to be aware of. Keep this patient card with you.

What is in this leaflet

1. What Hemlibra is and what it is used for
2. What you need to know before you use Hemlibra
3. How to use Hemlibra
4. Possible side effects
5. How to store Hemlibra
6. Contents of the pack and other information
7. Instructions for use

1. What Hemlibra is and what it is used for

What Hemlibra is

Hemlibra contains the active substance “emicizumab”. This belongs to a group of medicines called “monoclonal antibodies”. Monoclonal antibodies are a type of protein that recognise and bind to a target in the body.

What Hemlibra is used for

Hemlibra is a medicine used for treating patients of all ages with haemophilia A (congenital factor VIII deficiency):

- who have developed factor VIII inhibitors
- who have not developed factor VIII inhibitors with:
 - severe disease (the factor VIII blood level is less than 1%)
 - moderate disease (the factor VIII blood level is from 1% to 5%) with severe bleeding phenotype.

Haemophilia A is an inherited condition caused by a lack of factor VIII, an essential substance required for blood to clot and stop any bleeding.

The medicine prevents bleeding or reduces bleeding episodes in people with this condition.

Some patients with haemophilia A can develop factor VIII inhibitors (antibodies against factor VIII) which stop the replacement factor VIII from working.

How Hemlibra works

Hemlibra restores the function of missing activated factor VIII that is needed for effective blood clotting. Its structure is different from factor VIII, therefore Hemlibra is not affected by factor VIII inhibitors.

2. What you need to know before you use Hemlibra

Do not use Hemlibra

- if you are allergic to emicizumab or any of the other ingredients of this medicine (listed in section 6). If you are not sure, talk to your doctor, pharmacist or nurse before using Hemlibra.

Warnings and precautions

Before you start using Hemlibra, it is very important to talk to your doctor about using “bypassing agents” (medicines that help blood clot but which work in a different way from factor VIII). **This is because treatment with bypassing agents may need to change while receiving Hemlibra.** Examples of bypassing agents include activated prothrombin complex concentrate (aPCC) and recombinant FVIIa (rFVIIa). Serious and potentially life-threatening side effects can occur when aPCC is used in patients who are also receiving Hemlibra:

Potentially serious side effects of using aPCC while receiving Hemlibra

- **Destruction of red blood cells (thrombotic microangiopathy)**
 - This is a serious and potentially life-threatening condition.
 - When people have this condition, the lining of the blood vessels can be damaged and blood clots may develop in small blood vessels. In some cases, this can cause damage to the kidneys and other organs.
 - Be cautious if you are at high risk for this condition (have had this condition in the past, or a member of your family have suffered from it), or if you are taking medicines that can increase the risk of developing this condition, such as ciclosporin, quinine or tacrolimus.
 - It is important to know the symptoms of thrombotic microangiopathy, in case you develop the condition (see section 4, “Possible side effects” for a list of symptoms).

Stop using Hemlibra and aPCC, and talk to a doctor immediately if you or your caregiver notices any symptoms of thrombotic microangiopathy.

- **Blood clots (thromboembolism)**
 - In rare cases, a blood clot can form inside blood vessels and block them, which may be life-threatening.
 - It is important to know the symptoms of such internal blood clots, in case they develop (see section 4, “Possible side effects” for a list of symptoms).

Stop using Hemlibra and aPCC, and talk to a doctor immediately if you or your caregiver notices any symptoms of blood clots in blood vessels.

Other important information about Hemlibra

- **Antibody formation (immunogenicity)**

- You may notice that bleeding is not being controlled with your prescribed dose of this medicine. This could be due to the development of antibodies to this medicine.

Talk to a doctor immediately if you or your caregiver notices an increase in bleeds. Your doctor may decide to change your treatment if this medicine stops working for you.

Children below the age of 1 year

In children less than one year of age, the blood system is still developing. If your child is less than one year old, your doctor may prescribe Hemlibra only after carefully weighing the expected benefits and risks of using this product.

Other medicines and Hemlibra

Tell your doctor or pharmacist if you are using, have recently used or might use any other medicines.

- Using a bypassing agent while receiving Hemlibra
 - **Before you start using Hemlibra, talk to your doctor and carefully follow their instructions on when to use a bypassing agent and the dose and schedule you should use.** Hemlibra increases the ability of your blood to clot. Therefore, the dose of bypassing agent required may be lower than the dose you used before starting Hemlibra.
 - Use aPCC **only if** no other treatment can be used. If aPCC is required, talk to your doctor in case you feel you need a total of more than 50 units/kg of aPCC. For more information on using aPCC while receiving Hemlibra, see in section 2: “Potentially serious side effects of using aPCC while receiving Hemlibra”.
 - Despite limited experience with concomitant administration of anti-fibrinolytics with aPCC or rFVIIa in patients treated with Hemlibra, you should know that there may be a possibility of thrombotic events using anti-fibrinolytics administered intravenously in combination with aPCC or rFVIIa.

Laboratory tests

Tell your doctor if you are using Hemlibra before you have laboratory tests to measure how well your blood is clotting. This is because Hemlibra in the blood may interfere with some laboratory tests, leading to inaccurate results.

Pregnancy and breast-feeding

- You should use an effective method of birth control (contraception) during treatment with Hemlibra and for 6 months after your last injection of Hemlibra.
- If you are pregnant or breast-feeding, think you may be pregnant or are planning to have a baby, ask your doctor or pharmacist for advice before using this medicine. Your doctor will consider the benefit of you taking Hemlibra against the risk to your baby.

Driving and using machines

This medicine is not likely to affect your ability to drive or use machines.

3. How to use Hemlibra

Hemlibra is provided in single-use vials as ready to use solution which does not need to be diluted. A doctor qualified to care for patients with haemophilia will start you on treatment with Hemlibra. Always use this medicine exactly as your doctor has told you. Check with your healthcare provider if you are not sure.

Keeping a record

Each time you use Hemlibra, record the name and batch number of the medicine.

How much Hemlibra to use

The dose of Hemlibra depends on your weight and your doctor will calculate the amount (in mg) and corresponding amount of Hemlibra solution (in mL) to be injected:

- Loading dose regimen: Weeks 1 to 4: The dose is 3 milligrams for every 1 kilogram you weigh, injected once a week.
- Maintenance dose regimen: Week 5 and onwards: The dose is either 1.5 milligrams for every 1 kilogram you weigh, injected once a week, 3 milligrams for every 1 kilogram you weigh, injected every 2 weeks, or 6 milligrams for every 1 kilogram you weigh, injected every 4 weeks.

The decision, to use either the 1.5 mg/kg once weekly, 3 mg/kg every two weeks, or 6 mg/kg every four weeks maintenance dose, should be made in consultation with your doctor and, where applicable, with your caregiver.

Different Hemlibra concentrations (30 mg/mL and 150 mg/mL) **should not** be combined in a single injection when making up the total volume to be injected.

The amount of Hemlibra solution given in each injection must not be more than 2 mL.

How Hemlibra is given

If you inject Hemlibra yourself or if your caregiver injects it, you or your caregiver must carefully read and follow the instructions in section 7, “Instructions for use”.

- Hemlibra is given by injection under the skin (subcutaneously).
- Your doctor or nurse will show you how to inject Hemlibra.
- Once you have been trained, you should be able to inject this medicine at home, by yourself or with the help of a caregiver.
- To correctly insert the needle under the skin, pinch a fold of loose skin at the clean injection site with your free hand. Pinching the skin is important to ensure that you inject under the skin (into fatty tissue) but not any deeper (into muscle). Injecting into a muscle could cause discomfort.
- Prepare and give the injection in clean and germ-free conditions using aseptic technique. Your doctor or nurse will give more information about this.

Where to inject Hemlibra

- Your doctor will show you which areas of the body are suitable for injecting Hemlibra.
- The recommended places to give an injection are: the front of the waist (lower abdomen), upper outer arms, or the front of the thighs. Use only recommended places for injection.
- For each injection, use a different area of the body to the one you used last time.
- Do not give injections where the skin is red, bruised, tender, hard, or areas where there are moles or scars.
- When using Hemlibra, any other medicine injected under the skin should be given in a different area.

Using syringes and needles

- A syringe, a transfer needle with 5 micrometre filter or a vial adapter with 5 micrometre filter, and an injection needle are used to draw up the Hemlibra solution from the vial into the syringe and to inject it under the skin.
- Syringes, transfer needles with filter or vial adapter with filter, and injection needles are not provided in this pack. For more information, see in section 6 “What is needed for Hemlibra administration and is not contained in this pack”.
- Make sure that you use a new injection needle for each injection and dispose of it after a single use.
- A 1 mL syringe should be used for an injection up to 1 mL of Hemlibra solution.
- A 2 to 3 mL syringe should be used for an injection greater than 1 mL and up to 2 mL of Hemlibra solution.

Use in children and adolescents

Hemlibra can be used in adolescents and children of all ages.

- A child can self-inject the medicine provided the child’s healthcare provider and the parent or caregiver agree. Self-injection for children below the age of 7 years is not recommended.

If you use more Hemlibra than you should

If you use more Hemlibra than you are supposed to, tell your doctor immediately. This is because you may be at risk of developing side effects such as blood clots. Always use Hemlibra exactly as your doctor has told you, and check with your doctor, pharmacist or nurse if you are not sure.

If you forget to use Hemlibra

- If you forget your scheduled injection, inject the forgotten dose as soon as possible before the day of the next scheduled dose. Then, continue to inject the medicine as scheduled. Do not inject two doses on the same day to make up for a forgotten dose.
- If you are not sure what to do, ask your doctor, pharmacist or nurse.

If you stop using Hemlibra

Do not stop using Hemlibra without talking to your doctor. If you stop using Hemlibra, you may no longer be protected against bleeding.

If you have any further questions on the use of this medicine, ask your doctor, pharmacist or nurse.

4. Possible side effects

Like all medicines, this medicine can cause side effects, although not everybody gets them.

Serious side effects of using aPCC while receiving Hemlibra

Stop using Hemlibra and aPCC and talk to a doctor immediately if you or your caregiver notices any of the following side effects:

- **Destruction of red blood cells (thrombotic microangiopathy):**
 - confusion, weakness, swelling of arms and legs, yellowing of skin and eyes, vague belly (abdominal) or back pain, feeling sick (nausea), being sick (vomiting) or urinating less – these symptoms may be signs of thrombotic microangiopathy.
- **Blood clots (thromboembolism):**

- swelling, warmth, pain or redness – these symptoms may be signs of a blood clot in a vein near the surface of the skin.
- headache, numbness in your face, eye pain or swelling or problems with your vision – these symptoms may be signs of a blood clot in a vein behind your eye.
- blackening of the skin – this symptom may be a sign of severe damage to the skin tissue.

Other side effects when using Hemlibra

Very common: may affect more than 1 in 10 people

- a reaction in the area where the injection is given (redness, itching, pain)
- headache
- joint pain

Common: may affect up to 1 in 10 people

- fever
- muscle aches
- diarrhoea
- itchy rash or hives (urticaria)
- skin rash

Uncommon: may affect up to 1 in 100 people

- destruction of red blood cells (thrombotic microangiopathy)
- blood clot in a vein behind your eye (cavernous sinus thrombosis)
- severe damage of the skin tissue (skin necrosis)
- blood clot in a vein near the surface of the skin (superficial thrombophlebitis)
- swollen face, tongue and/or throat and/or difficulty in swallowing, or hives, together with difficulty in breathing which are suggestive of an angioedema
- lack of effect or decreased response to treatment

Reporting of side effects

If you get any side effects, talk to your doctor, pharmacist or nurse. This includes any possible side effects not listed in this leaflet. You can also report side effects directly via [the national reporting system listed in Appendix V](#). By reporting side effects, you can help provide more information on the safety of this medicine.

5. How to store Hemlibra

Keep this medicine out of the sight and reach of children.

Do not use this medicine after the expiry date which is stated on the carton and the vial label after “EXP”. The expiry date refers to the last day of that month.

Store in a refrigerator (2°C - 8°C). Do not freeze.

Store in the original pack in order to protect from light.

Once removed from the refrigerator, unopened vials may be kept at room temperature (below 30°C) for up to 7 days. After storage at room temperature, unopened vials may be returned back to the refrigerator. The total time the medicine is stored at room temperature should not be more than 7 days.

Discard vials that have been kept at room temperature for more than 7 days or exposed to temperatures above 30°C.

Once transferred from the vial to the syringe, use Hemlibra straight away. Do not refrigerate the solution in the syringe.

Before using the medicine, check the solution for particles or discoloration. The solution should be colourless to slightly yellow. Do not use this medicine if it is cloudy, discoloured, or contains visible particles.

Throw away any unused solution appropriately. Do not throw away any medicines via wastewater or household waste. Ask your pharmacist how to throw away medicines you no longer use. These measures will help protect the environment.

6. Contents of the pack and other information

What Hemlibra contains

- The active substance is emicizumab. Each vial of Hemlibra contains 12 mg (0.4 mL at a concentration of 30 mg/mL) or 30 mg (1 mL at a concentration of 30 mg/mL) of emicizumab.
- The other ingredients are L-arginine, L-histidine, L-aspartic acid, poloxamer 188 and water for injections.

What Hemlibra looks like and contents of the pack

Hemlibra is a solution for injection. It is a colourless to slightly yellow liquid.

Each pack of Hemlibra contains 1 glass vial.

Not all pack sizes may be marketed.

What is needed for Hemlibra administration and is not contained in this pack

A syringe, a transfer needle with filter or a vial adapter with filter, and an injection needle are needed to withdraw the Hemlibra solution from the vial to a syringe and inject it under the skin (see section 7, "Instructions for use").

Syringes

- **1 mL syringe:** Transparent polypropylene or polycarbonate syringe with Luer-lock tip, graduation 0.01 mL **or**
- **2 to 3 mL syringe:** Transparent polypropylene or polycarbonate syringe with Luer-lock tip, graduation 0.1 mL.

Note: Syringes with Low Dead Space (LDS) Plunger should be used when using the vial adapter with filter.

Transfer devices and needles

- **Transfer needle with filter:** Stainless steel with Luer-lock connection, gauge 18 G, length 35 mm (1½"), containing a 5 micrometre filter and preferably with semi-blunted tip **or**
- **Vial adapter with filter:** Polypropylene with Luer-lock connection, integrating a 5 micrometre filter, fitting 15 mm vial neck outer diameter **and**
- **Injection needle:** Stainless steel with Luer-lock connection, gauge 26 G (acceptable range: 25-27 gauge), length preferably 9 mm (3/8") or maximally 13 mm (½"), preferably including needle safety feature.

Marketing Authorisation Holder

Roche Registration GmbH
Emil-Barell-Strasse 1
79639 Grenzach-Wyhlen
Germany

Manufacturer

Roche Pharma AG
Emil-Barell-Strasse 1
79639 Grenzach-Wyhlen
Germany

For any information about this medicine, please contact the local representative of the Marketing Authorisation Holder:

België/Belgique/Belgien
N.V. Roche S.A.
Tél/Tel: +32 (0) 2 525 82 11

България
Рош България ЕООД
Тел: +359 2 474 54 44

Česká republika
Roche s. r. o.
Tel: +420 - 2 20382111

Danmark
Roche Pharmaceuticals A/S
Tlf: +45 - 36 39 99 99

Deutschland
Roche Pharma AG
Tel: +49 (0) 7624 140

Eesti
Roche Eesti OÜ
Tel: + 372 - 6 177 380

Ελλάδα
Roche (Hellas) A.E.
Τηλ: +30 210 61 66 100

España
Roche Farma S.A.
Tel: +34 - 91 324 81 00

France
Roche
Tél: +33 (0) 1 47 61 40 00

Lietuva
UAB "Roche Lietuva"
Tel: +370 5 2546799

Luxembourg/Luxemburg
(Voir/siehe Belgique/Belgien)

Magyarország
Roche (Magyarország) Kft.
Tel: +36 - 1 279 4500

Malta
(See Ireland)

Nederland
Roche Nederland B.V.
Tel: +31 (0) 348 438050

Norge
Roche Norge AS
Tlf: +47 - 22 78 90 00

Österreich
Roche Austria GmbH
Tel: +43 (0) 1 27739

Polska
Roche Polska Sp.z o.o.
Tel: +48 - 22 345 18 88

Portugal
Roche Farmacêutica Química, Lda
Tel: +351 - 21 425 70 00

Hrvatska

Roche d.o.o.
Tel: +385 1 4722 333

Ireland

Roche Products (Ireland) Ltd.
Tel: +353 (0) 1 469 0700

Ísland

Roche Pharmaceuticals A/S
c/o Icepharma hf
Sími: +354 540 8000

Italia

Roche S.p.A.
Tel: +39 - 039 2471

Κύπρος

Γ.Α.Σταμάτης & Σια Λτδ.
Τηλ: +357 - 22 76 62 76

Latvija

Roche Latvija SIA
Tel: +371 - 6 7039831

România

Roche România S.R.L.
Tel: +40 21 206 47 01

Slovenija

Roche farmacevtska družba d.o.o.
Tel: +386 - 1 360 26 00

Slovenská republika

Roche Slovensko, s.r.o.
Tel: +421 - 2 52638201

Suomi/Finland

Roche Oy
Puh/Tel: +358 (0) 10 554 500

Sverige

Roche AB
Tel: +46 (0) 8 726 1200

United Kingdom (Northern Ireland)

Roche Products (Ireland) Ltd.
Tel: +44 (0) 1707 366000

This leaflet was last revised in

Other sources of information

Detailed information on this medicine is available on the European Medicines Agency web site:
<http://www.ema.europa.eu>

7. Instructions for use

Transfer Needle with Filter Option (for transfer of medicine from vial to syringe)



Instructions for Use Hemlibra Injection Single-Dose Vial(s)

You must read, understand and follow the Instructions for Use before injecting Hemlibra. Your healthcare provider should show you how to prepare, measure, and inject Hemlibra properly before you use it for the first time. Ask your healthcare provider if you have any questions.

Important Information:

Do not use these instructions when using a Vial Adapter to withdraw Hemlibra from the vial. These instructions are for use with the Transfer Needle only.

- **Do not** inject yourself or someone else unless you have been shown how to by your healthcare provider.
- Make sure the name Hemlibra is on the box and vial label.
- Before opening the vial, read the vial label to make sure you have the correct medicine strength(s) to give the dose prescribed for you. You may need to use more than 1 vial to give yourself the correct dose.
- Check the expiry date on the box and vial label. **Do not** use if the expiry date has passed.
- **Only use the vial once.** After you inject your dose, throw away any unused Hemlibra left in the vial. Do not save unused medicine in the vial for later use.
- **Only use the syringes, transfer needles and injection needles that your healthcare provider prescribes.**
- **Use the syringes, transfer needles and injection needles only once. Throw away any used caps, vial(s) and syringes and needles.**
- If your prescribed dose is more than 2 mL, you will need to have more than one subcutaneous injection of Hemlibra; contact your healthcare provider for the injection instructions.
- You must inject Hemlibra only under the skin.

Storing Hemlibra vials:

- Keep the vial in the refrigerator (2°C to 8°C). **Do not** freeze.

- Keep the vial in the original box to protect the medicine from light.
- Once removed from the refrigerator, the unopened vial can be kept at room temperature (below 30°C) for up to 7 days. After storage at room temperature unopened vials may be returned to the refrigerator. The total amount of time outside cold storage and at room temperature should not exceed 7 days.
- Discard vials that have been kept at room temperature for more than 7 days or have been in temperatures above 30°C.
- Keep the vials, out of the sight and reach of children.
- Take the vial out of the refrigerator 15 minutes before use and allow it to reach room temperature (below 30°C) before preparing an injection.
- **Do not** shake the vial.

Storing needles and syringes:

- Keep the transfer needle, injection needle and syringe dry.
- Keep the transfer needle, injection needle and syringe out of the sight and reach of children.

Inspecting the medicine and your supplies:

- Collect all supplies listed below to prepare and give your injection.
- **Check** the expiry date on the box, on the vial label and on the supplies listed below. **Do not** use if the expiry date has passed.
- **Do not** use the vial if:
 - the medicine is cloudy, hazy or coloured.
 - the medicine contains particles.
 - the cap covering the stopper is missing.
- Inspect the supplies for damage. Do not use if they appear damaged or if they have been dropped.
- Place the supplies on a clean, well-lit flat work surface.

Included in the box:

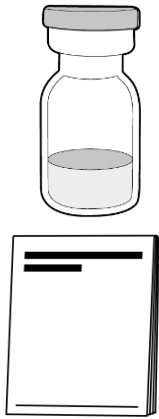

- **Vial containing the medicine**
- **Hemlibra Instructions for Use**

Not included in the box:

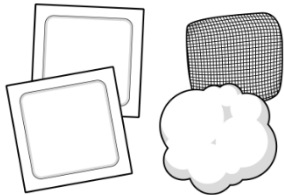

- **Alcohol wipes**
Note: If you need to use more than 1 vial to inject your prescribed dose, you must use a new alcohol wipe for each vial.
- **Gauze**
- **Cotton ball**

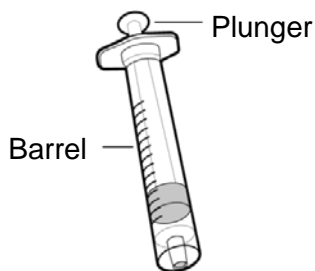

- **Syringe**
- For injection amount up to 1 mL use a **1 mL syringe**.
- For injection amount between 1 mL and 2 mL use a **2 mL or 3 mL syringe**.
- **Note: Do not** use 2 or 3 mL syringe for doses up to 1 mL.

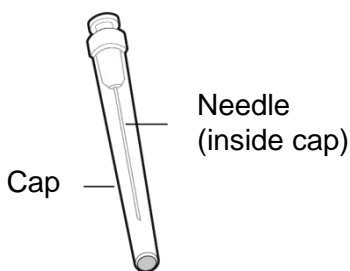

- **18G Transfer needle with 5 micrometre filter**
Note: If you need to use more than 1 vial to inject your prescribed dose, you must use a new transfer needle for each vial.
- **Do not** use the transfer needle to inject the medicine.

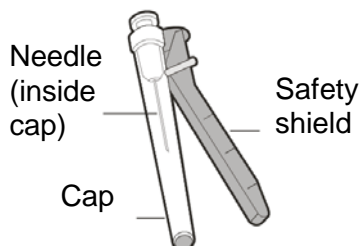

- Injection needle with safety shield (Used to inject medicine).
- **Do not** use the injection needle to withdraw medicine from vial.



- **Sharps disposal container**

Get ready:

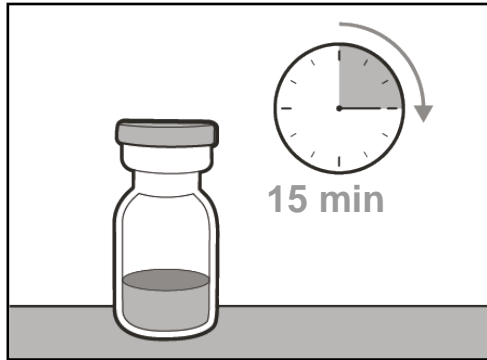

- Before use, allow the vial(s) to reach room temperature for about 15 minutes on a clean flat surface away from direct sunlight.
- **Do not** try to warm the vial by any other way.
-
- **Wash your hands** well with soap and water.

Selecting and preparing an injection site:

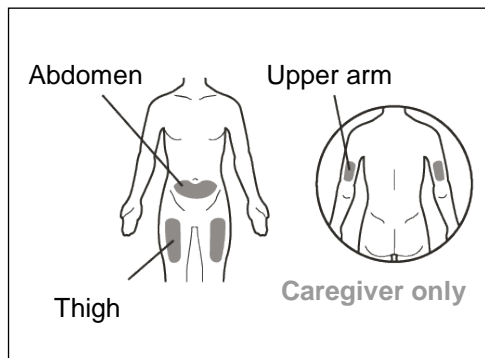

- Clean the chosen injection site area using an alcohol wipe.
- Let the skin dry for about 10 seconds.
- **Do not** touch, fan or blow on the cleaned area before your injection.

For your injection, you can use your:

- Thigh (front and middle).
- Stomach area (abdomen), except for the 5 cm around the navel (belly button).
- Outer area of the upper arm (only if a caregiver is giving the injection).
- You should use a different injection site for each injection, at least 2.5 cm away from the area you used for any previous injection.
- **Do not** inject into areas that could be irritated by a belt or waistband.
- **Do not** inject into moles, scars, bruises, or areas where the skin is tender, red, hard or the skin is broken.

Preparing the syringe for injection:

- Once the syringe has been filled with the medicine, the injection must be given immediately.
- Once the injection needle cap has been removed, the medicine in the syringe must be injected under the skin within 5 minutes.
- **Do not** touch exposed needles or place them on a surface once the cap has been removed.
- **Do not** use the syringe if the needle touches any surface.

Important information after the injection:

- **If you see drops of blood at the injection site, you can press a sterile cotton ball or gauze over the injection site for at least 10 seconds, until bleeding has stopped.**
- If you have bruising (small area of bleeding under the skin), an ice pack can also be pressed gently on the site. If bleeding does not stop, please contact your healthcare provider.
- **Do not** rub the injection site after injection.

Disposing of the medicine and supplies:

Important: Always keep the sharps disposal container out of reach of children.

- **Throw away any used caps, vial(s), needles and syringes in a sharps or puncture-proof container.** Put your used needles and syringes in a sharps disposal container straight away after use. **Do not** throw away any loose caps, vials, needles and syringes in your household waste.
- If you do not have a sharps disposal container, you may use a household container that is:
 - made of heavy-duty plastic.
 - can be closed with a tight-fitting, puncture resistant lid, without sharps being able to come out.
 - upright and stable during use.
 - leak-resistant.
 - properly labelled to warn of hazardous waste inside the container.
- When your sharps disposal container is almost full, you will need to follow your local guidelines for the right way to throw away of your sharps disposal container.
- **Do not** throw away any used sharps disposal container in your household waste unless your local guidelines permit this. **Do not** recycle your used sharps disposal container.

1. PREPARATION

Step 1. Remove vial cap and clean top



- Take the cap off the vial(s).
- Throw away the vial cap(s) into the sharps disposal container.

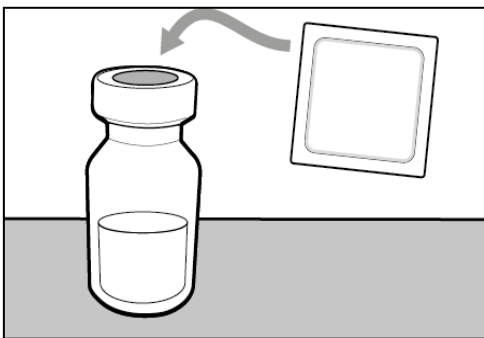

- Clean the top of the vial(s) stopper with an alcohol wipe.

Step 2. Attach transfer needle with filter to syringe

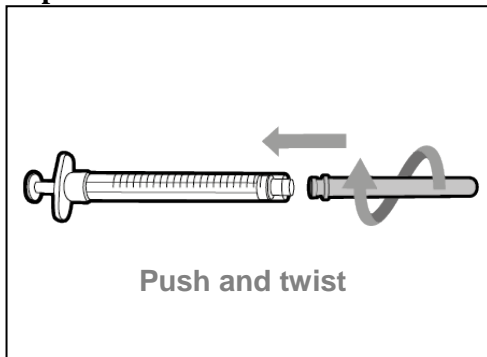

- **Push and twist the transfer needle with filter clockwise** on to the syringe until it is fully attached.

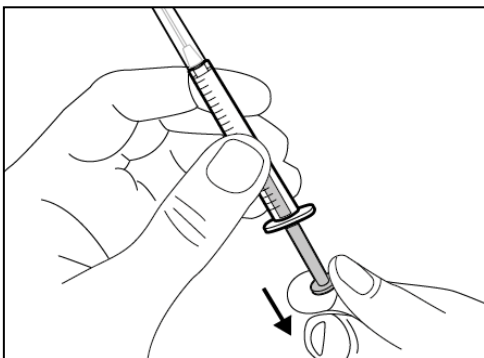

- Slowly pull back on the plunger and draw air into the syringe that is the same amount as your prescribed dose.

Step 3. Uncap transfer needle

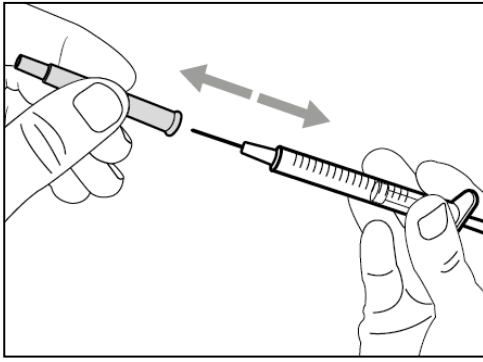

- Hold the syringe by the barrel with the transfer needle pointing up.
- Carefully pull the transfer needle cap straight off and away from your body. **Do not throw the cap away. Place the transfer needle cap down on a clean flat surface.** You will need to recap the transfer needle after transferring the medicine.
- **Do not** touch the needle tip or place it on a surface after the needle cap has been removed.

Step 4. Inject air into vial

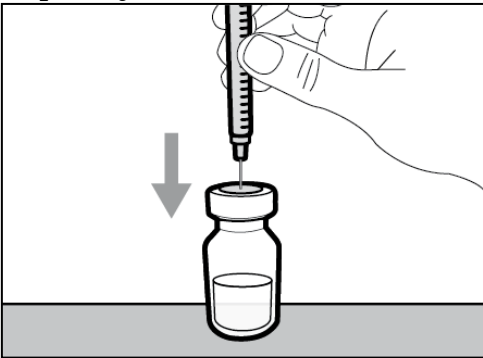

- Keep the vial on the flat working surface and insert the transfer needle and syringe straight down into the centre of the vial stopper.

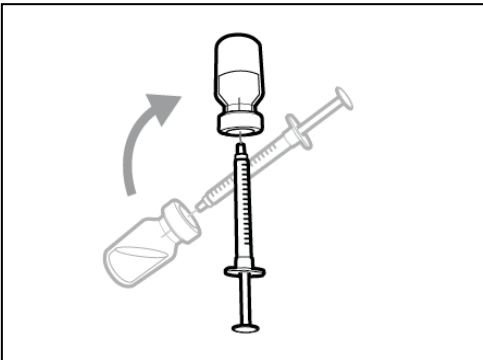

- Keep the needle in the vial and turn the vial upside down.

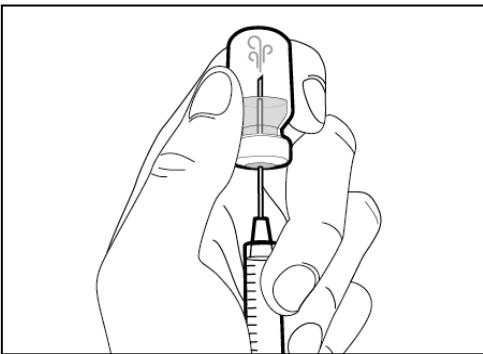

- With the needle pointing upwards, push on the plunger to inject the air from the syringe **above the medicine.**
- Keep your finger pressed down on the syringe plunger.
- **Do not** inject air into the medicine as this could create air bubbles or foam in the medicine.

Step 5. Transfer medicine to syringe

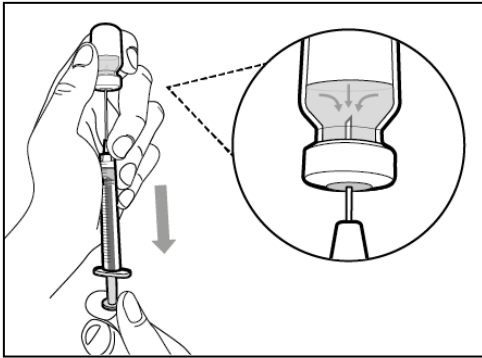

- Slide the tip of the needle down so that it is **within the medicine**.
- With the syringe pointing upwards, slowly pull back the plunger to **fill the syringe with** more than the amount of **medicine** needed for your prescribed dose.
- **Hold the plunger firmly** to ensure it does not pull back in
- Be careful not to pull the plunger out of the syringe.

Important: If your prescribed dose is more than the amount of Hemlibra in the vial, **withdraw all medicine** and go to the “**Combining Vials**” section now.

Step 6. Remove air bubbles

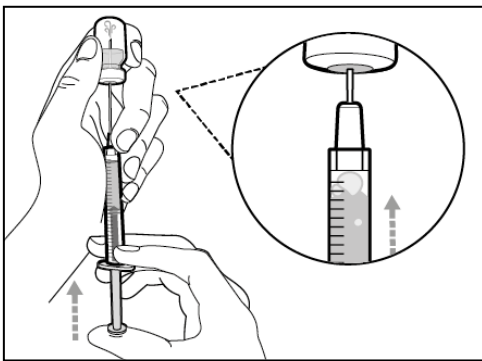

- Keep the needle in the vial and check the syringe for larger air bubbles. Large air bubbles can reduce the dose you receive.

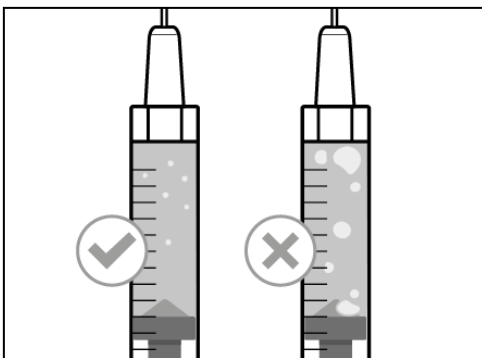

- **Remove the larger air bubbles** by gently **tapping** the syringe barrel with your fingers until the air bubbles rise to the top of the syringe. Move the tip of the needle **above the medicine** and slowly push the plunger up to push the air bubbles out of the syringe.
- If the amount of medicine in the syringe is now at or below your prescribed dose, move the tip of the needle to **within the medicine** and slowly pull back the plunger until you have **more** than the amount of medicine needed for your **prescribed dose**.
- Be careful not to pull the plunger out of the syringe.
- Repeat the steps above until you have removed the larger air bubbles.

Note: Ensure you have enough medicine in the syringe to complete your dose before moving onto the next step. If you cannot remove all medicine, turn the vial upright to reach the remaining amount.

⚠ Do not use the transfer needle to inject medicine as this may cause pain and bleeding.

2. INJECTION

Step 7. Recap transfer needle

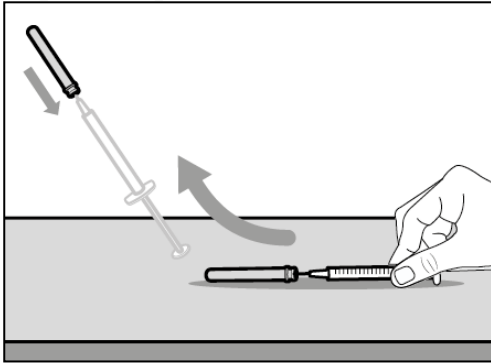

- Remove the syringe and transfer needle from the vial.
- **Using one hand, slide** the transfer needle into the cap and **scoop upwards** to cover the needle.
- Once the needle is covered, push the transfer needle cap towards the syringe to fully attach it with **one hand** to prevent accidentally injuring yourself with the needle

Step 8. Clean injection site

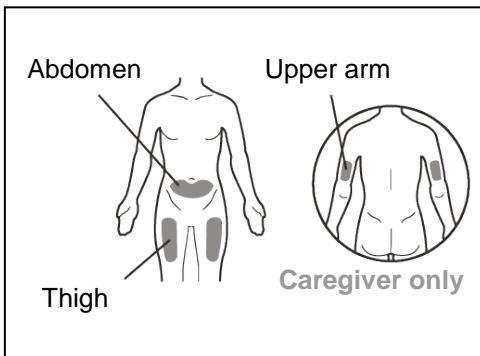

- Select and **clean** your injection site with an alcohol wipe.

Step 9. Remove the used transfer needle from the syringe

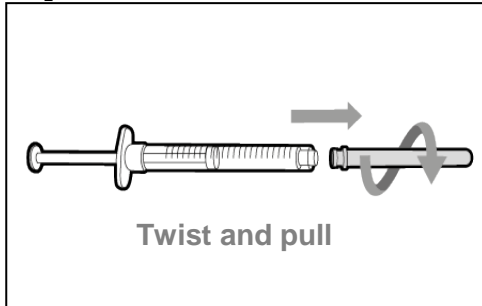

- Remove the used transfer needle from the syringe by twisting anticlockwise and gently pulling.
- Throw away the used transfer needle into a sharps disposal container.

Step 10. Attach injection needle to syringe

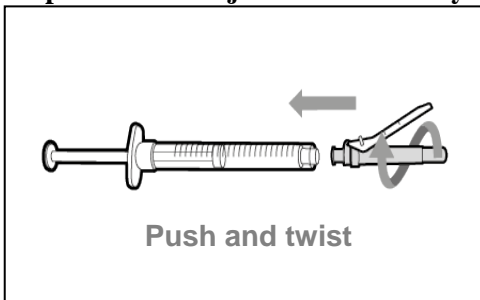

- Push and twist the injection needle clockwise onto the syringe until it is fully attached.

Step 11. Move safety shield

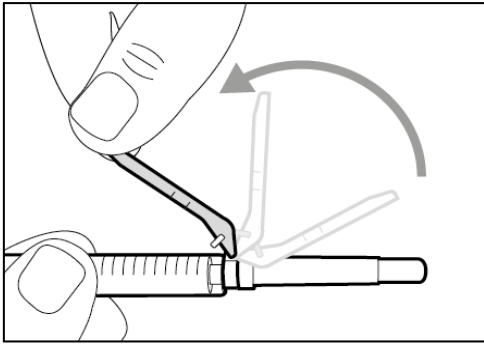

- Move the safety shield away from the needle and **towards** the syringe barrel.

Step 12. Uncap injection needle

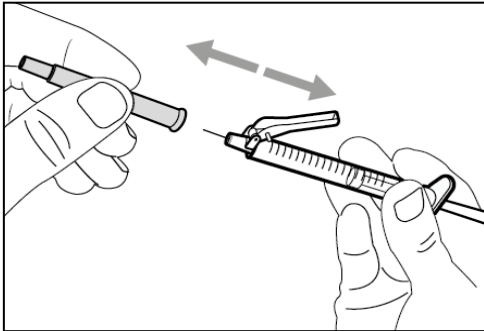

- **Carefully** pull the injection needle cap **straightaway** from the syringe.
- Throw away the cap into a sharps disposal container.
- Do not touch the needle tip or allow it to touch any surface.
- After the injection needle cap has been removed, the medicine in the syringe must be injected within 5 minutes.

Step 13. Adjust plunger to prescribed dose

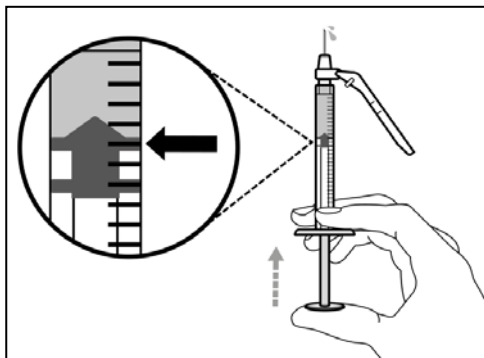

- Hold the syringe with the needle pointing up and slowly push the plunger to your prescribed dose.
- **Check your dose**, ensure the top rim of the plunger is in line with the mark on the syringe for your prescribed dose.

Step 14. Subcutaneous (under the skin) injection

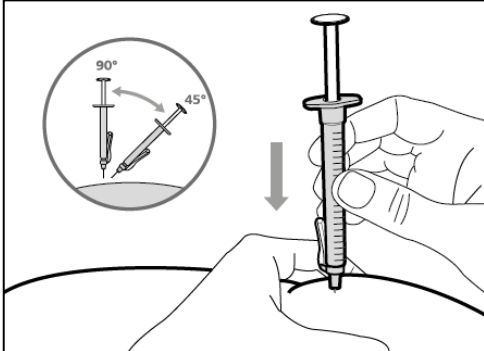

- Pinch the selected injection site and fully insert the needle at a **45° to 90° angle** with a quick, firm action. **Do not** hold or push on the plunger while inserting the needle.
- Hold the position of the syringe and let go of the pinched injection site.

Step 15. Inject the medicine

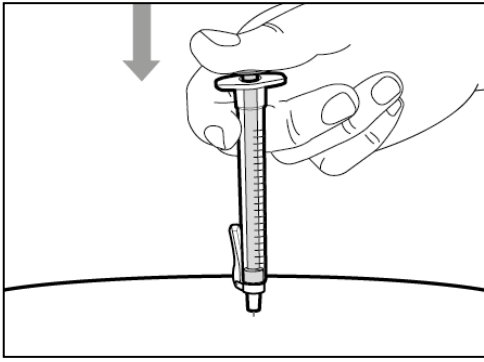

- Slowly inject all of the medicine by gently pushing the plunger all the way down.
- Remove the needle and syringe from the injection site at the same angle as inserted.

3. DISPOSAL

Step 16. Cover needle with safety shield

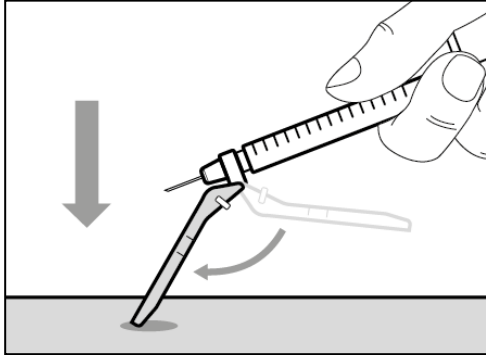

- Move the safety shield forward 90°, away from the syringe barrel.
- **Holding the syringe with one hand, press the safety shield down** against a flat surface with a firm, quick motion until you hear a “click”.

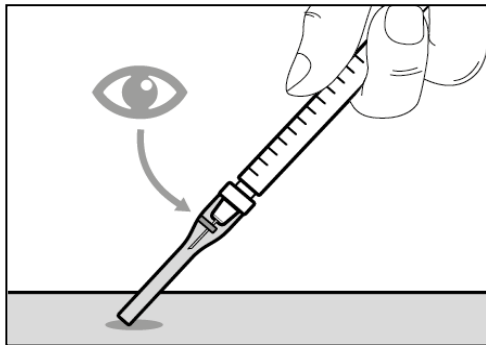

- If you do not hear a click, look to see that the needle is fully covered by the safety shield.
- Keep your fingers behind the safety shield and away from the needle at all times.
- **Do not** detach the injection needle.

Step 17. Throw away the syringe and needle

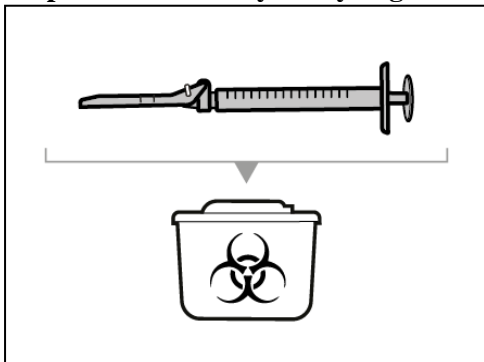

- Put your used needles and syringes in a sharps disposal container right away after use. For further information refer to the section “Disposing of the medicine and supplies”.
- **Do not** try to remove the used injection needle from the used syringe.
- **Do not** recap the injection needle with the cap.
- **Important:** Always keep the sharps disposal container out of reach of children.
- Throw away any used caps, vial(s), needles and syringes in a sharps or puncture-proof container

Combining Vials

If you need to use more than 1 vial to get to your prescribed dose, follow these steps after you have drawn up the medicine from the first vial as described in step 5. You must use a new transfer needle for each vial.

Step A. Recap transfer needle

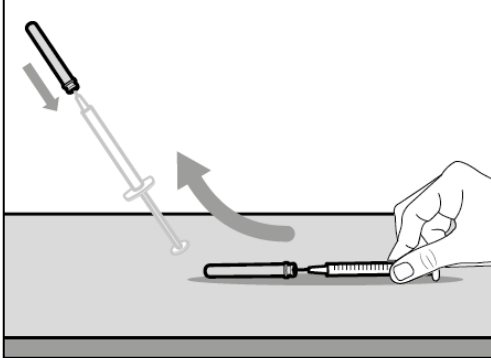

- Remove the syringe and transfer needle from the vial.
- **Using one hand, slide** the transfer needle into the cap and **scoop upwards** to cover the needle.
- Once the needle is covered, push the transfer needle cap towards the syringe to fully attach it with **one hand** to prevent accidentally injuring yourself with the needle

Step B. Remove the used transfer needle from the syringe

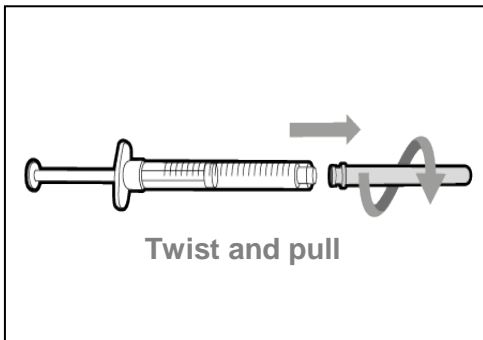

- Remove the used transfer needle from the syringe by twisting anticlockwise and gently pulling.
- Throw away the used transfer needle into a sharps disposal container.

Step C. Attach a new transfer needle with filter to the syringe

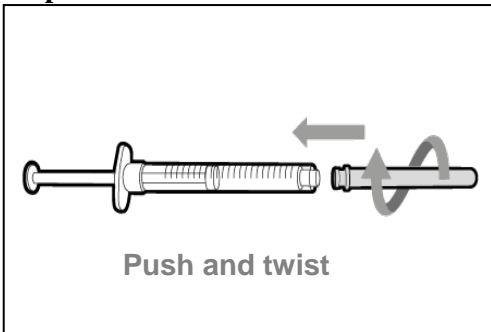

- Push and twist a new transfer needle clockwise onto the syringe until it is fully attached.
- Slowly pull back the plunger and draw some air into the syringe.

Step D. Uncap transfer needle

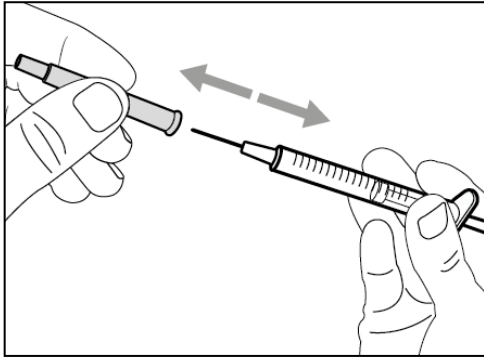

- Hold the syringe by the barrel with the transfer needle pointing up.
- Carefully pull the transfer needle cap straight off and away from your body. **Do not throw the cap away.** You will need to recap the transfer needle after transferring the medicine.
- **Do not** touch the needle tip.

Step E. Inject air into vial

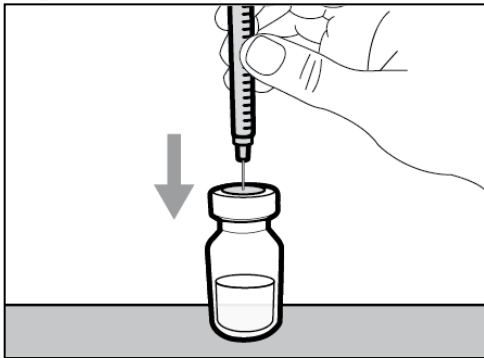

- With the new vial on the flat working surface, insert the new transfer needle and syringe, straight down into the centre of the vial stopper.

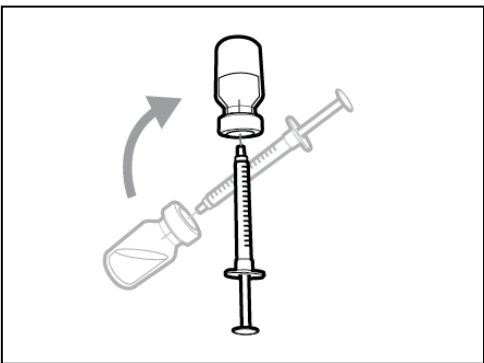

- Keep the needle in the vial and turn the vial upside down.

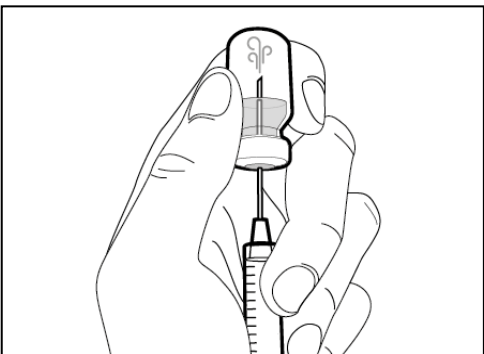

- With the needle pointing upwards, push on the plunger to inject the air from the syringe **above the medicine.**
- Keep your finger pressed down on the syringe plunger.
- **Do not** inject air into the medicine as this could create air bubbles or foam in the medicine.

Step F. Transfer medicine to syringe

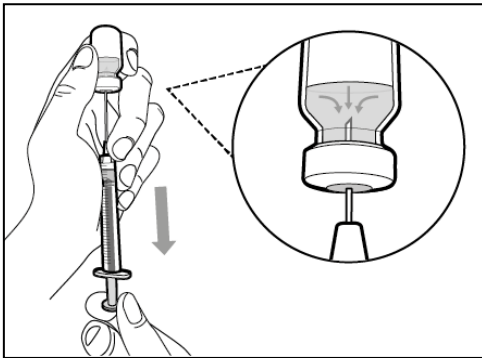

- Slide the tip of the needle down so that it is **within the medicine**.
- With the syringe pointing upwards, slowly pull back the plunger to **fill the syringe with** more than the amount **of medicine** needed for your prescribed dose.
- **Hold the plunger firmly** to ensure it does not pull back in
- Be careful not to pull the plunger out of the syringe.

Note: Ensure you have enough medicine in the syringe to complete your dose before moving onto the next steps. If you cannot remove all medicine, turn the vial upright to reach the remaining amount.

! Do not use the transfer needle to inject medicine as this may cause pain and bleeding.

Repeat steps A to F with each additional vial until you have more than the amount of medicine needed for your prescribed dose. Once completed, keep the transfer needle inserted in the vial and return to Step 6 “Remove air bubbles”. Continue with the remaining steps.

Vial adapter with Filter
Option
(for transfer of medicine from vial to syringe)



Instructions for Use
Hemlibra
Injection
Single-Dose Vial(s)

You must read, understand and follow the Instructions for Use before injecting Hemlibra. Your healthcare provider should show you how to prepare, measure, and inject Hemlibra properly before you use it for the first time. Ask your healthcare provider if you have any questions.

Important Information:

Do not use these instructions when using a transfer needle to withdraw Hemlibra from the vial. These instructions are for use with the Vial Adapter only.

- **Do not** inject yourself or someone else unless you have been shown how to by your healthcare provider.
- Make sure the name Hemlibra is on the box and vial label.
- Before opening the vial, read the vial label to make sure you have the correct medicine strength(s) to give the dose prescribed for you. You may need to use more than 1 vial to give yourself the correct dose.
- Check the expiry date on the box and vial label. **Do not** use if the expiry date has passed
- **Only use the vial once.** After you inject your dose, throw away any unused Hemlibra left in the vial. **Do not** save unused medicine in the vial for later use.
- **Only use the syringes, vial adapters, and injection needles that your healthcare provider prescribes.**
- **Use the syringes, vial adapters and injection needles only once. Throw away any used caps, vial(s) and syringes and needles.**
- If your prescribed dose is more than 2 mL, you will need to have more than one subcutaneous injection of Hemlibra; contact your healthcare provider for the injection instructions.
- You must inject Hemlibra only under the skin.

Storing Hemlibra vials:

- Store the vial in the refrigerator (2°C to 8°C). **Do not** freeze.
- Keep the vial in the original box to protect the medicine from light.

- Once removed from the refrigerator, the unopened vial can be kept at room temperature (below 30°C) for up to 7 days. After storage at room temperature unopened vials may be returned to the refrigerator. The total amount of time outside cold storage and at room temperature should not exceed 7 days.
- Discard vials that have been kept at room temperature for more than 7 days or have been in temperatures above 30°C.
- Keep vials out of the sight and reach of children.
- Take the vial out of the refrigerator 15 minutes before use and allow it to reach room temperature (below 30°C) before preparing an injection.
- **Do not** shake the vial.

Storing vial adapters, needles and syringes:

- Keep the vial adapter, injection needle and syringe dry.
- Keep the vial adapter, injection needle and syringe out of the sight and reach of children

Inspecting the medicine and your supplies:

- Collect all supplies listed below to prepare and give your injection.
- **Check** the expiry date on the box, on the vial label, and on the supplies listed below. **Do not** use if the expiry date has passed.
- **Do not** use the vial if:
 - the medicine is cloudy, hazy or coloured.
 - the medicine contains particles.
 - the cap covering the stopper is missing.
- Inspect the supplies for damage. **Do not** use if they appear damaged or if they have been dropped.
- Place the supplies on a clean, well-lit flat work surface.

Included in the box:



- **Vial containing the medicine**



- **Hemlibra Instructions for Use**

Not included in the box:

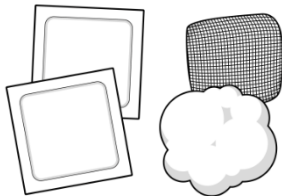

- **Alcohol wipes**
Note: If you need to use more than 1 vial to inject your prescribed dose, you must use a new alcohol wipe for each vial.

- **Gauze**
- **Cotton ball**

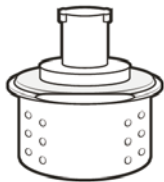

- **Vial adapter with filter** (To be added on top of vial).

Note: Used for withdrawing medicine from the vial to the syringe. If you need to use more than 1 vial to inject your prescribed dose, you must use a new vial adapter for each vial.

- ⚠ **Do not insert injection needle into vial adapter.**

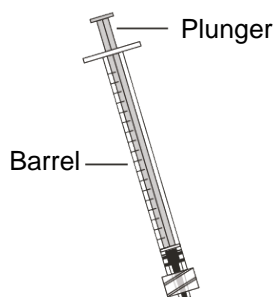

- **Syringe with Low Dead Space (LDS) Plunger**
Important:

- For injection amount up to 1 mL use **1 mL LDS syringe**
- For injection amount over 1 mL use **2 or 3 mL LDS syringes.**

Note: Do not use 2 or 3 mL LDS syringes for doses up to 1 mL

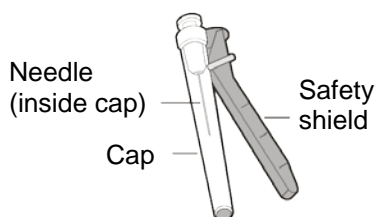

- Injection needle with safety shield (Used to inject medicine).
- **Do not** insert the injection needle into vial adapter or use the injection needle to withdraw medicine from vial.

- **Sharps disposal container**



Get ready:

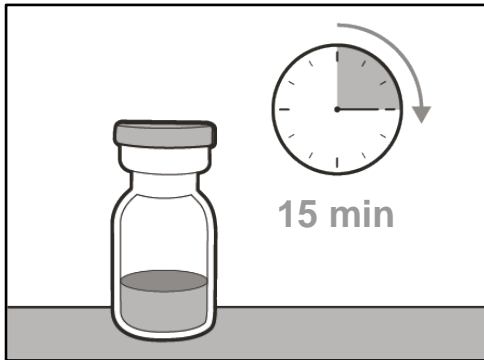

- Before use, allow the vial(s) to reach room temperature for about 15 minutes on a clean flat surface away from direct sunlight.
- **Do not** try to warm the vial by any other way.
- **Wash your hands** well with soap and water.

Selecting and preparing an injection site:

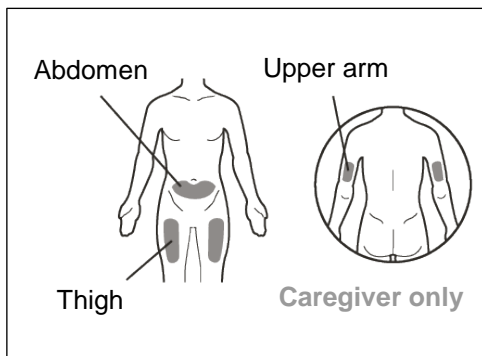

- Clean the chosen injection site area using an alcohol wipe.
- Let the skin dry for about 10 seconds.
- **Do not** touch, fan or blow on the cleaned area before your injection.

For your injection, you can use your:

- Thigh (front and middle).
- Stomach area (abdomen), except for the 5 cm around the navel (belly button).
- Outer area of the upper arm (only if a caregiver is giving the injection).
- You should use a different injection site for each injection, at least 2.5 cm away from the area you used for any previous injection.
- **Do not** inject into areas that could be irritated by a belt or waistband.
- **Do not** inject into moles, scars, bruises, or areas where the skin is tender, red, hard or the skin is broken.

Preparing the syringe for injection:

- Once the syringe has been filled with the medicine, the injection must be given immediately.
- Once the injection needle cap has been removed, the medicine in the syringe must be injected under the skin within 5 minutes.

- **Do not** touch exposed needles or place them on a surface once the cap has been removed.
- **Do not** use the syringe if the needle touches any surface.

Important information after the injection:

- **If you see drops of blood at the injection site, you can press a sterile cotton ball or gauze over the injection site for at least 10 seconds, until bleeding has stopped.**
- If you have bruising (small area of bleeding under the skin), an ice pack can also be pressed gently on the site. If bleeding does not stop, please contact your healthcare provider.
- **Do not** rub the injection site after injection.

Disposing of the medicine and supplies:

Important: Always keep the sharps disposal container out of reach of children.

- **Throw away any used caps, vial(s), vial adapters, needles and syringes in a sharps or puncture-proof container.**
- Put your used vial adapters, needles and syringes in a sharps disposal container straight away after use. **Do not** throw away any loose caps, vials, needles and syringes in your household waste.
- If you do not have a sharps disposal container, you may use a household container that is:
 - made of heavy-duty plastic.
 - can be closed with a tight-fitting, puncture resistant lid, without sharps being able to come out.
 - upright and stable during use.
 - leak-resistant.
 - properly labelled to warn of hazardous waste inside the container.
- When your sharps disposal container is almost full, you will need to follow your local guidelines for the right way to throw away of your sharps disposal container.
- **Do not** throw away any used sharps disposal container in your household waste unless your local guidelines permit this. **Do not** recycle your used sharps disposal container.

1. PREPARATION

Step 1. Remove vial cap and clean top



- Take the cap off the vial(s).
- Throw away the vial cap(s) into the sharps disposal container.

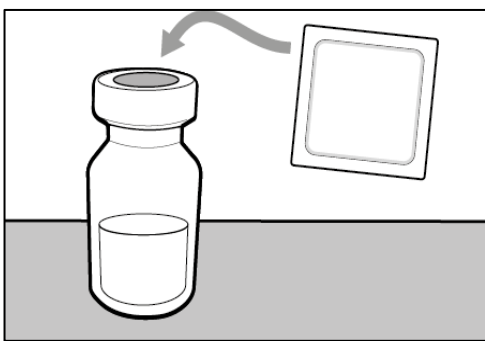

- Clean the top of the vial(s) stopper with an alcohol wipe.

Step 2. Insert vial adapter onto vial

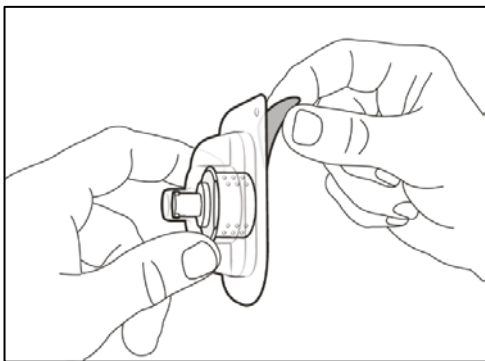

- Peel off back to open the blister pack.
- ⚠ **Do not** remove the vial adapter from the clear plastic blister pack.

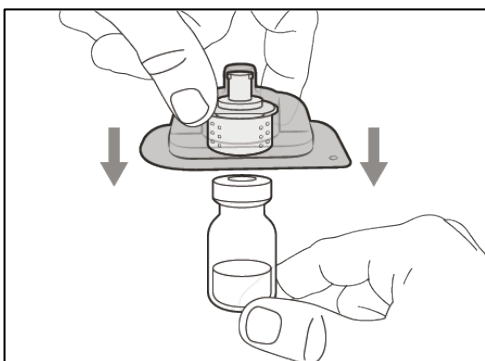

- Firmly press down the plastic blister pack with the vial adapter onto the new vial, until you hear a “click”.

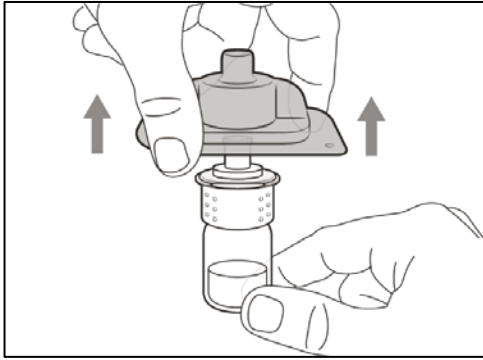

- Remove and throw away the plastic blister pack.
- **Do not** touch the tip of vial adapter.

Step 3. Connect syringe to vial adapter

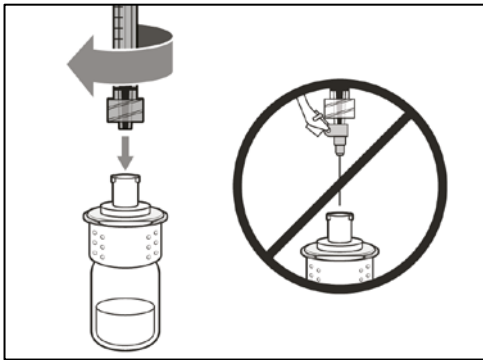

- **Remove syringe cap** (if required).
- **Push and twist the syringe clockwise** on to the vial adapter until it is fully attached.

Step 4. Transfer medicine to syringe

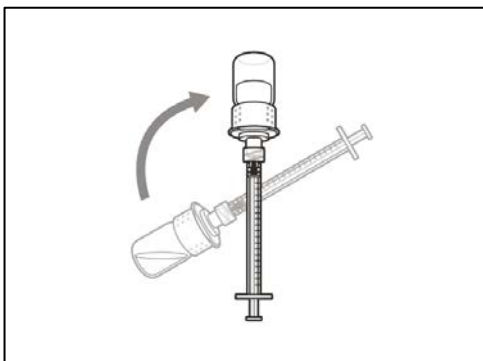

- Keep the vial adapter attached to the syringe and turn the vial upside down.

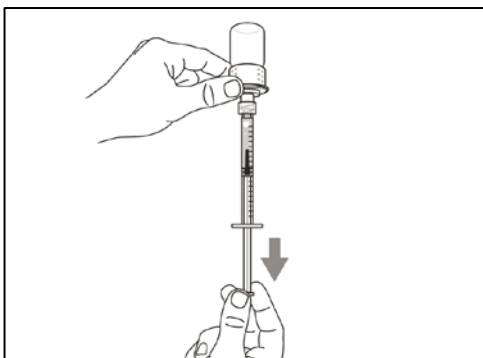

- With the syringe pointing upwards, slowly pull back the plunger to **fill the syringe with** more than the amount **of medicine** needed for your prescribed dose.
- **Hold plunger firmly** to ensure it does not pull back in.
- Be careful not to pull the plunger out of the syringe.

Important: If your prescribed dose is more than the amount of Hemlibra in the vial, **withdraw all medicine** and go to the “**Combining Vials**” section now.

Step 5. Remove air bubbles

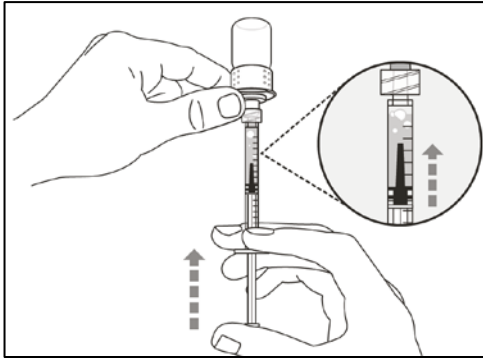

- Keep the vial attached to the syringe and **check the syringe for larger air bubbles**. Large air bubbles can reduce the dose you receive.

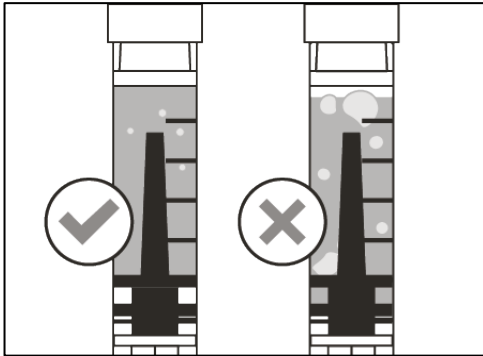

- **Remove the larger air bubbles** by gently **tapping** the syringe barrel with your finger until the air bubbles rise to the top of the syringe. **Slowly push the plunger** to push the large air bubbles out of the syringe.
- If the amount of medicine in the syringe is now at or below your prescribed dose, slowly pull back the plunger until you have **more** than the amount of medicine needed for your **prescribed dose**.
- Be careful not to pull the plunger out of the syringe.
- Repeat the steps above until you have removed the large air bubbles.

Note: Ensure you have enough medicine in the syringe to complete your dose before moving on to the next step.

2. INJECTION

Step 6. Clean injection site

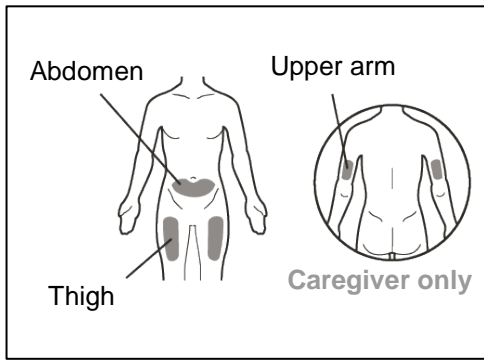

- Select and **clean** your injection site with an alcohol wipe.

Step 7. Remove syringe from vial adapter

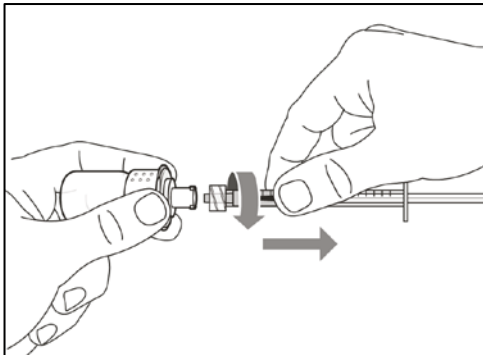

- Remove the syringe from the vial adapter by twisting anticlockwise and gently pulling.
- Throw away the used vial/vial adapter into a sharps disposal container.

Step 8. Attach injection needle to syringe

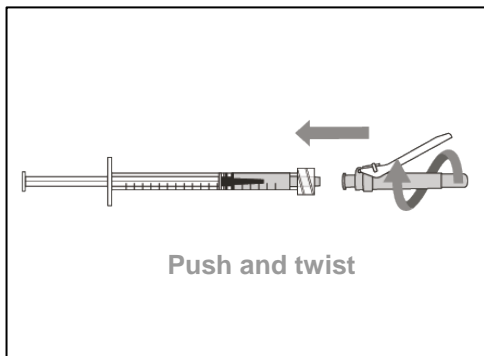

- Push and twist the injection needle clockwise onto the syringe until it is fully attached.
- **Do not** insert the injection needle into vial adapter or use the injection needle to withdraw medicine from vial.

Step 9. Move safety shield

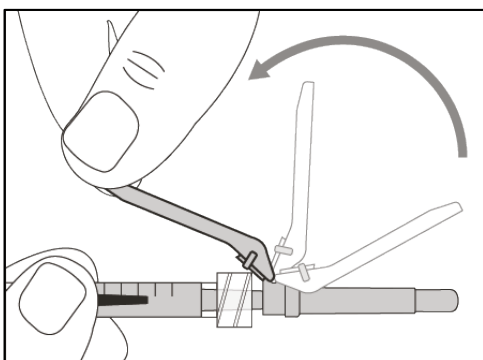

- Move the safety shield away from the needle and **towards** the syringe barrel.

Step 10. Uncap injection needle

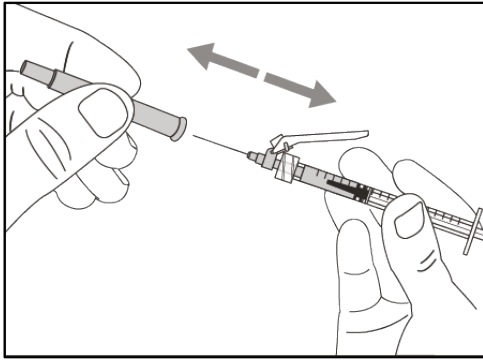

- **Carefully** pull the injection needle cap **straightaway** from the syringe.
- Throw away the cap into a sharps disposal container.
- **Do not** touch the needle tip or allow it to touch any surface.
- After the injection needle cap has been removed, the medicine in the syringe must be injected within 5 minutes.

Step 11. Adjust plunger to prescribed dose

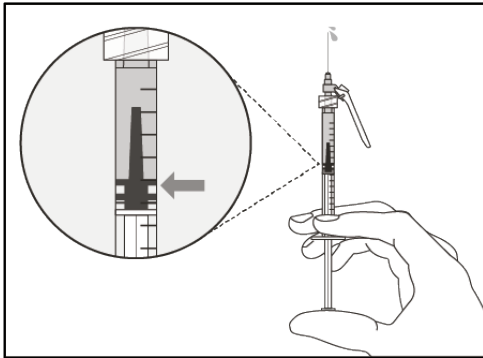

- Hold the syringe with the needle pointing up and slowly push the plunger to your prescribed dose.
- **Check your dose**, ensure the top rim of the plunger is in line with the mark on the syringe for your prescribed dose.

Step 12. Subcutaneous (under the skin) injection

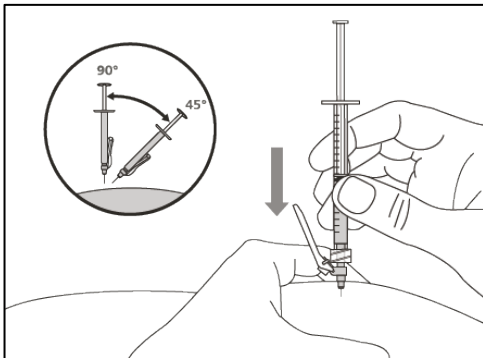

- Pinch the selected injection site and fully insert the needle at a **45° to 90°** angle with a quick, firm action. **Do not** hold or push on the plunger while inserting the needle.
- Hold the position of the syringe and let go of the pinched injection site.

Step 13. Inject the medicine

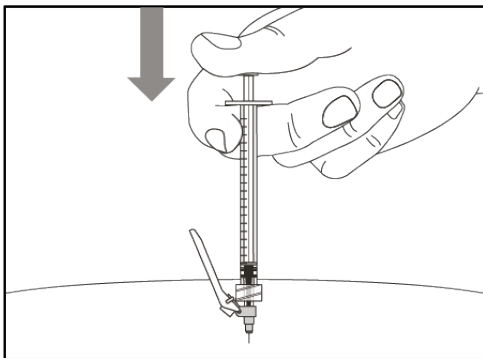

- Slowly inject all of the medicine by gently pushing the plunger all the way down.
- Remove the needle and syringe from the injection site at the same angle as inserted.

3. DISPOSAL

Step 14. Cover needle with safety shield

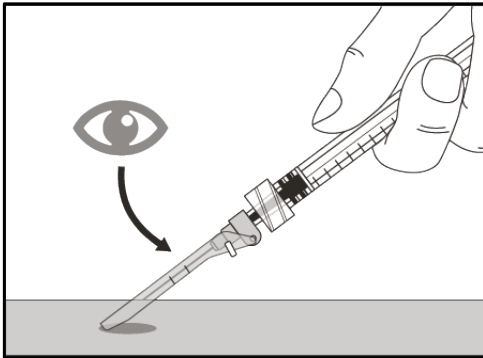
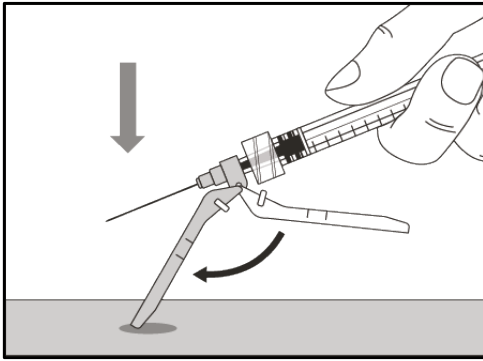

- Move the safety shield forward 90°, away from the syringe barrel.
- **Holding the syringe with one hand, press the safety shield down** against a flat surface with a firm, quick motion until you hear a “click”.
- If you do not hear a click, look to see that the needle is fully covered by the safety shield.
- Keep your fingers behind the safety shield and away from the needle at all times.
- **Do not** detach the injection needle.

Step 15. Throw away the needle and syringe

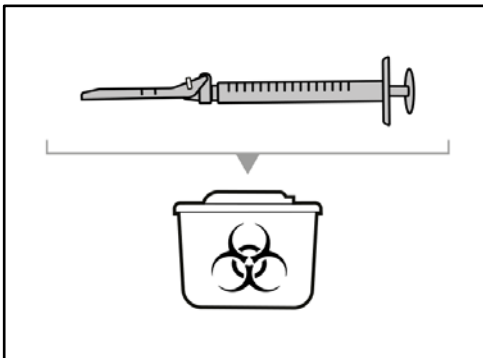

- Put your used needles and syringes in a sharps disposal container right away after use. For further information refer to the section “Disposing of the medicine and supplies”.
- **Do not** try to remove the used injection needle from the used syringe.
- **Do not** recap the injection needle with the cap.
- **Important:** Always keep the sharps disposal container out of reach of children.
- Throw away any used caps, vial(s), vial adapters, needles and syringes in a sharps or puncture-proof container.

Combining Vials

If you need to use more than 1 vial to get to your prescribed dose, follow these steps after you have drawn up the medicine from the first vial as described in step 4. You must use a new vial adapter for each vial.

Step A. Insert new vial adapter into new vial

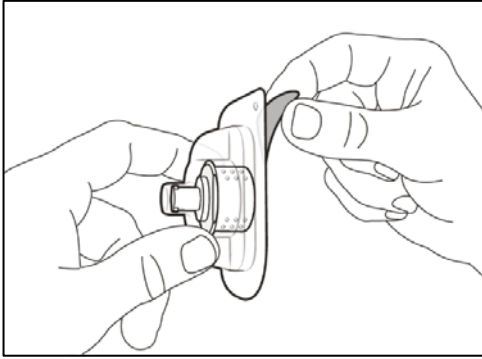

- Peel off back to open the blister pack.
- ⚠ **Do not** remove the vial adapter from the clear plastic blister pack.

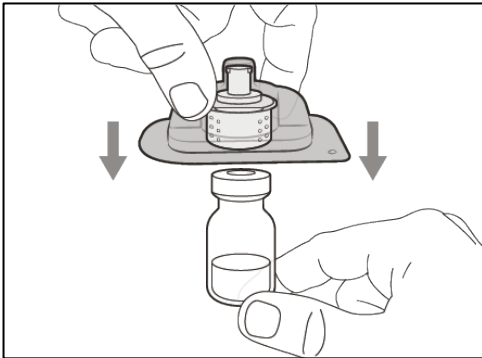

- Firmly press down the plastic blister pack with the vial adapter onto the new vial, until you hear a “click”.

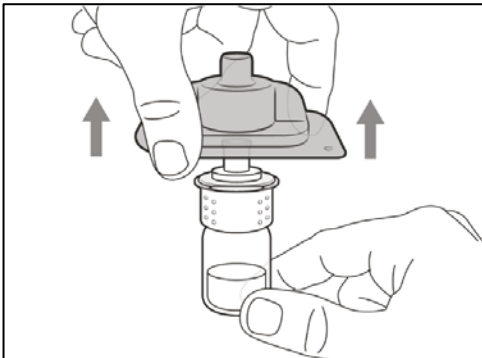

- Remove and throw away the plastic blister pack.
- **Do not** touch the tip of vial adapter.

Step B. Remove syringe from used vial adapter

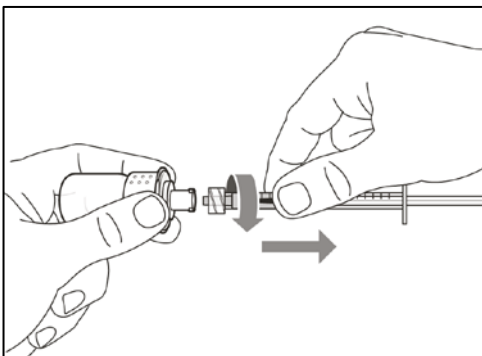

- Remove the syringe from the used vial adapter by twisting anticlockwise and gently pulling.
- Throw away the used vial/vial adapter into a sharps disposal container.

Step C. Connect syringe to new vial adapter

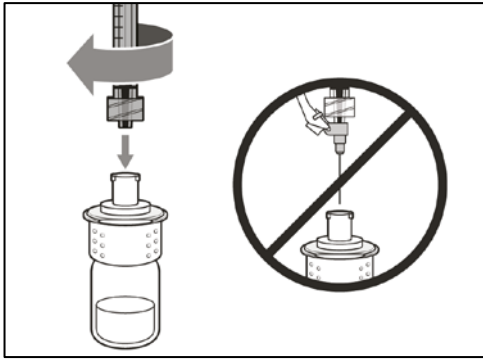

- **Push and twist the same syringe clockwise** on to the next vial adapter until it is fully attached.

Step D. Transfer medicine into syringe

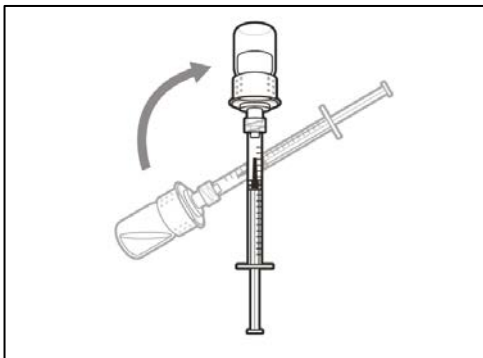

- Keep the vial adapter attached to the syringe and turn the vial upside down.

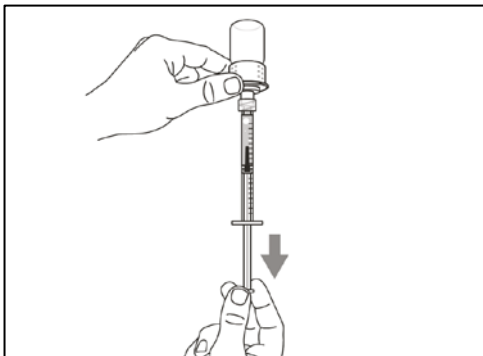

- With the syringe pointing upwards, slowly pull back the plunger to **fill the syringe with** more than the amount **of the medicine** needed for your prescribed dose.
- **Hold plunger firmly** to ensure it does not pull back in.
- Be careful not to pull the plunger out of the syringe.

Note: Ensure you have enough medicine in the syringe to complete your dose before moving on to the next step.

Repeat steps A to D with each additional vial until you have more than the amount of medicine needed for your prescribed dose. Once completed, keep the vial adapter onto the vial and return to Step 5 “Remove air bubbles”. Continue with the remaining steps.

Package leaflet: Information for the user

Hemlibra 150 mg/mL solution for injection emicizumab

Read all of this leaflet carefully before you start using this medicine because it contains important information for you.

- Keep this leaflet. You may need to read it again.
- If you have any further questions, ask your doctor, pharmacist or nurse.
- This medicine has been prescribed for you only. Do not pass it on to others. It may harm them, even if their signs of illness are the same as yours.
- If you get any side effects, talk to your doctor, pharmacist or nurse. This includes any possible side effects not listed in this leaflet. See section 4.

In addition to this leaflet, your doctor will give you a patient card, which contains important safety information that you need to be aware of. Keep this patient card with you.

What is in this leaflet

1. What Hemlibra is and what it is used for
2. What you need to know before you use Hemlibra
3. How to use Hemlibra
4. Possible side effects
5. How to store Hemlibra
6. Contents of the pack and other information
7. Instructions for use

1. What Hemlibra is and what it is used for

What Hemlibra is

Hemlibra contains the active substance “emicizumab”. This belongs to a group of medicines called “monoclonal antibodies”. Monoclonal antibodies are a type of protein that recognise and bind to a target in the body.

What Hemlibra is used for

Hemlibra is a medicine used for treating patients of all ages with haemophilia A (congenital factor VIII deficiency):

- who have developed factor VIII inhibitors
- who have not developed factor VIII inhibitors with:
 - severe disease (the factor VIII blood level is less than 1%)
 - moderate disease (the factor VIII blood level is from 1% to 5%) with severe bleeding phenotype.

Haemophilia A is an inherited condition caused by a lack of factor VIII, an essential substance required for blood to clot and stop any bleeding.

The medicine prevents bleeding or reduces bleeding episodes in people with this condition.

Some patients with haemophilia A can develop factor VIII inhibitors (antibodies against factor VIII) which stop the replacement factor VIII from working.

How Hemlibra works

Hemlibra restores the function of missing activated factor VIII that is needed for effective blood clotting. Its structure is different from factor VIII, therefore Hemlibra is not affected by factor VIII inhibitors.

2. What you need to know before you use Hemlibra

Do not use Hemlibra

- if you are allergic to emicizumab or any of the other ingredients of this medicine (listed in section 6). If you are not sure, talk to your doctor, pharmacist or nurse before using Hemlibra.

Warnings and precautions

Before you start using Hemlibra, it is very important to talk to your doctor about using “bypassing agents” (medicines that help blood clot but which work in a different way from factor VIII). **This is because treatment with bypassing agents may need to change while receiving Hemlibra.** Examples of bypassing agents include activated prothrombin complex concentrate (aPCC) and recombinant FVIIa (rFVIIa). Serious and potentially life-threatening side effects can occur when aPCC is used in patients who are also receiving Hemlibra:

Potentially serious side effects of using aPCC while receiving Hemlibra

- **Destruction of red blood cells (thrombotic microangiopathy)**
 - This is a serious and potentially life-threatening condition.
 - When people have this condition, the lining of the blood vessels can be damaged and blood clots may develop in small blood vessels. In some cases, this can cause damage to the kidneys and other organs.
 - Be cautious if you are at high risk for this condition (have had this condition in the past, or a member of your family have suffered from it), or if you are taking medicines that can increase the risk of developing this condition, such as ciclosporin, quinine or tacrolimus.
 - It is important to know the symptoms of thrombotic microangiopathy, in case you develop the condition (see section 4, “Possible side effects” for a list of symptoms).

Stop using Hemlibra and aPCC, and talk to a doctor immediately if you or your caregiver notices any symptoms of thrombotic microangiopathy.

- **Blood clots (thromboembolism)**
 - In rare cases, a blood clot can form inside blood vessels and block them, which may be life-threatening.
 - It is important to know the symptoms of such internal blood clots, in case they develop (see section 4, “Possible side effects” for a list of symptoms).

Stop using Hemlibra and aPCC, and talk to a doctor immediately if you or your caregiver notices any symptoms of blood clots in blood vessels.

Other important information about Hemlibra

- **Antibody formation (immunogenicity)**

- You may notice that bleeding is not being controlled with your prescribed dose of this medicine. This could be due to the development of antibodies to this medicine.

Talk to a doctor immediately if you or your caregiver notices an increase in bleeds. Your doctor may decide to change your treatment if this medicine stops working for you.

Children below the age of 1 year

In children less than one year of age, the blood system is still developing. If your child is less than one year old, your doctor may prescribe Hemlibra only after carefully weighing the expected benefits and risks of using this product.

Other medicines and Hemlibra

Tell your doctor or pharmacist if you are using, have recently used or might use any other medicines.

- Using a bypassing agent while receiving Hemlibra
 - **Before you start using Hemlibra, talk to your doctor and carefully follow their instructions on when to use a bypassing agent and the dose and schedule you should use.** Hemlibra increases the ability of your blood to clot. Therefore, the dose of bypassing agent required may be lower than the dose you used before starting Hemlibra.
 - Use aPCC **only if** no other treatment can be used. If aPCC is required, talk to your doctor in case you feel you need a total of more than 50 units/kg of aPCC. For more information on using aPCC while receiving Hemlibra, see in section 2: “Potentially serious side effects of using aPCC while receiving Hemlibra”.
 - Despite limited experience with concomitant administration of anti-fibrinolytics with aPCC or rFVIIa in patients treated with Hemlibra, you should know that there may be a possibility of thrombotic events using anti-fibrinolytics administered intravenously in combination with aPCC or rFVIIa.

Laboratory tests

Tell your doctor if you are using Hemlibra before you have laboratory tests to measure how well your blood is clotting. This is because Hemlibra in the blood may interfere with some laboratory tests, leading to inaccurate results.

Pregnancy and breast-feeding

- You should use an effective method of birth control (contraception) during treatment with Hemlibra and for 6 months after your last injection of Hemlibra.
- If you are pregnant or breast-feeding, think you may be pregnant or are planning to have a baby, ask your doctor or pharmacist for advice before using this medicine. Your doctor will consider the benefit of you taking Hemlibra against the risk to your baby.

Driving and using machines

This medicine is not likely to affect your ability to drive or use machines.

3. How to use Hemlibra

Hemlibra is provided in single-use vials as ready to use solution which does not need to be diluted. A doctor qualified to care for patients with haemophilia will start you on treatment with Hemlibra. Always use this medicine exactly as your doctor has told you. Check with your healthcare provider if you are not sure.

Keeping a record

Each time you use Hemlibra, record the name and batch number of the medicine.

How much Hemlibra to use

The dose of Hemlibra depends on your weight and your doctor will calculate the amount (in mg) and corresponding amount of Hemlibra solution (in mL) to be injected:

- Loading dose regimen: Weeks 1 to 4: The dose is 3 milligrams for every 1 kilogram you weigh, injected once a week.
- Maintenance dose regimen: Week 5 and onwards: The dose is either 1.5 milligrams for every 1 kilogram you weigh, injected once a week, 3 milligrams for every 1 kilogram you weigh, injected every 2 weeks, or 6 milligrams for every 1 kilogram you weigh, injected every 4 weeks.

The decision, to use either the 1.5 mg/kg once weekly, 3 mg/kg every two weeks, or 6 mg/kg every four weeks maintenance dose, should be made in consultation with your doctor and, where applicable, with your caregiver.

Different Hemlibra concentrations (30 mg/mL and 150 mg/mL) **should not** be combined in a single injection when making up the total volume to be injected.

The amount of Hemlibra solution given in each injection must not be more than 2 mL.

How Hemlibra is given

If you inject Hemlibra yourself or if your caregiver injects it, you or your caregiver must carefully read and follow the instructions in section 7, “Instructions for use”.

- Hemlibra is given by injection under the skin (subcutaneously).
- Your doctor or nurse will show you how to inject Hemlibra.
- Once you have been trained, you should be able to inject this medicine at home, by yourself or with the help of a caregiver.
- To correctly insert the needle under the skin, pinch a fold of loose skin at the clean injection site with your free hand. Pinching the skin is important to ensure that you inject under the skin (into fatty tissue) but not any deeper (into muscle). Injecting into a muscle could cause discomfort.
- Prepare and give the injection in clean and germ-free conditions using aseptic technique. Your doctor or nurse will give more information about this.

Where to inject Hemlibra

- Your doctor will show you which areas of the body are suitable for injecting Hemlibra.
- The recommended places to give an injection are: the front of the waist (lower abdomen), upper outer arms, or the front of the thighs. Use only recommended places for injection.
- For each injection, use a different area of the body to the one you used last time.
- Do not give injections where the skin is red, bruised, tender, hard, or areas where there are moles or scars.
- When using Hemlibra, any other medicine injected under the skin should be given in a different area.

Using syringes and needles

- A syringe, a transfer needle with 5 micrometre filter or a vial adapter with 5 micrometre filter, and an injection needle are used to draw up the Hemlibra solution from the vial into the syringe and to inject it under the skin.
- Syringes, transfer needles with filter or vial adapter with filter, and injection needles are not provided in this pack. For more information, see in section 6 “What is needed for Hemlibra administration and is not contained in this pack”.
- Make sure that you use a new injection needle for each injection and dispose of it after a single use.
- A 1 mL syringe should be used for an injection up to 1 mL of Hemlibra solution.
- A 2 to 3 mL syringe should be used for an injection greater than 1 mL and up to 2 mL of Hemlibra solution.

Use in children and adolescents

Hemlibra can be used in adolescents and children of all ages.

- A child can self-inject the medicine provided the child’s healthcare provider and the parent or caregiver agree. Self-injection for children below the age of 7 years is not recommended.

If you use more Hemlibra than you should

If you use more Hemlibra than you are supposed to, tell your doctor immediately. This is because you may be at risk of developing side effects such as blood clots. Always use Hemlibra exactly as your doctor has told you, and check with your doctor, pharmacist or nurse if you are not sure.

If you forget to use Hemlibra

- If you forget your scheduled injection, inject the forgotten dose as soon as possible before the day of the next scheduled dose. Then, continue to inject the medicine as scheduled. Do not inject two doses on the same day to make up for a forgotten dose.
- If you are not sure what to do, ask your doctor, pharmacist or nurse.

If you stop using Hemlibra

Do not stop using Hemlibra without talking to your doctor. If you stop using Hemlibra, you may no longer be protected against bleeding.

If you have any further questions on the use of this medicine, ask your doctor, pharmacist or nurse.

4. Possible side effects

Like all medicines, this medicine can cause side effects, although not everybody gets them.

Serious side effects of using aPCC while receiving Hemlibra

Stop using Hemlibra and aPCC and talk to a doctor immediately if you or your caregiver notices any of the following side effects:

- **Destruction of red blood cells (thrombotic microangiopathy):**
 - confusion, weakness, swelling of arms and legs, yellowing of skin and eyes, vague belly (abdominal) or back pain, feeling sick (nausea), being sick (vomiting) or urinating less – these symptoms may be signs of thrombotic microangiopathy.
- **Blood clots (thromboembolism):**

- swelling, warmth, pain or redness – these symptoms may be signs of a blood clot in a vein near the surface of the skin.
- headache, numbness in your face, eye pain or swelling or problems with your vision – these symptoms may be signs of a blood clot in a vein behind your eye.
- blackening of the skin – this symptom may be a sign of severe damage to the skin tissue.

Other side effects when using Hemlibra

Very common: may affect more than 1 in 10 people

- a reaction in the area where the injection is given (redness, itching, pain)
- headache
- joint pain

Common: may affect up to 1 in 10 people

- fever
- muscle aches
- diarrhoea
- itchy rash or hives (urticaria)
- skin rash

Uncommon: may affect up to 1 in 100 people

- destruction of red blood cells (thrombotic microangiopathy)
- blood clot in a vein behind your eye (cavernous sinus thrombosis)
- severe damage of the skin tissue (skin necrosis)
- blood clot in a vein near the surface of the skin (superficial thrombophlebitis)
- swollen face, tongue and/or throat and/or difficulty in swallowing, or hives, together with difficulty in breathing which are suggestive of an angioedema
- lack of effect or decreased response to treatment

Reporting of side effects

If you get any side effects, talk to your doctor, pharmacist or nurse. This includes any possible side effects not listed in this leaflet. You can also report side effects directly via [the national reporting system listed in Appendix V](#). By reporting side effects, you can help provide more information on the safety of this medicine.

5. How to store Hemlibra

Keep this medicine out of the sight and reach of children.

Do not use this medicine after the expiry date which is stated on the carton and the vial label after “EXP”. The expiry date refers to the last day of that month.

Store in a refrigerator (2°C - 8°C). Do not freeze.

Store in the original pack in order to protect from light.

Once removed from the refrigerator, unopened vials may be kept at room temperature (below 30°C) for up to 7 days. After storage at room temperature, unopened vials may be returned back to the refrigerator. The total time the medicine is stored at room temperature should not be more than 7 days.

Discard vials that have been kept at room temperature for more than 7 days or exposed to temperatures above 30°C.

Once transferred from the vial to the syringe, use Hemlibra straight away. Do not refrigerate the solution in the syringe.

Before using the medicine, check the solution for particles or discoloration. The solution should be colourless to slightly yellow. Do not use this medicine if it is cloudy, discoloured, or contains visible particles.

Throw away any unused solution appropriately. Do not throw away any medicines via wastewater or household waste. Ask your pharmacist how to throw away medicines you no longer use. These measures will help protect the environment.

6. Contents of the pack and other information

What Hemlibra contains

- The active substance is emicizumab. Each vial of Hemlibra contains 60 mg (0.4 mL at a concentration of 150 mg/mL), 105 mg (0.7 mL at a concentration of 150 mg/mL), 150 mg (1 mL at a concentration of 150 mg/mL) or 300 mg (2 mL at a concentration of 150 mg/mL) of emicizumab.
- The other ingredients are L-arginine, L-histidine, L-aspartic acid, poloxamer 188 and water for injections.

What Hemlibra looks like and contents of the pack

Hemlibra is a solution for injection. It is a colourless to slightly yellow liquid.

Each pack of Hemlibra contains 1 glass vial.

Not all pack sizes may be marketed.

What is needed for Hemlibra administration and is not contained in this pack

A syringe, a transfer needle with filter or a vial adapter with filter, and an injection needle are needed to withdraw the Hemlibra solution from the vial to a syringe and inject it under the skin (see section 7, "Instructions for use").

Syringes

- **1 mL syringe:** Transparent polypropylene or polycarbonate syringe with Luer-lock tip, graduation 0.01 mL **or**
- **2 to 3 mL syringe:** Transparent polypropylene or polycarbonate syringe with Luer-lock tip, graduation 0.1 mL.

Note: Syringes with Low Dead Space (LDS) Plunger should be used when using the vial adapter with filter.

Transfer devices and needles

- **Transfer needle with filter:** Stainless steel with Luer-lock connection, gauge 18 G, length 35 mm (1½"), containing a 5 micrometre filter and preferably with semi-blunted tip **or**
- **Vial adapter with filter:** Polypropylene with Luer-lock, integrating a 5 micrometre filter, fitting 15 mm vial neck outer diameter **and**
- **Injection needle:** Stainless steel with Luer-lock connection, gauge 26 G (acceptable range: 25-27 gauge), length preferably 9 mm (3/8") or maximally 13 mm (½"), preferably including needle safety feature.

Marketing Authorisation Holder

Roche Registration GmbH
Emil-Barell-Strasse 1
79639 Grenzach-Wyhlen
Germany
Manufacturer

Roche Pharma AG
Emil-Barell-Strasse 1
79639 Grenzach-Wyhlen
Germany

For any information about this medicine, please contact the local representative of the Marketing Authorisation Holder:

België/Belgique/Belgien
N.V. Roche S.A.
Tél/Tel: +32 (0) 2 525 82 11

Lietuva
UAB “Roche Lietuva”
Tel: +370 5 2546799

България
Рош България ЕООД
Тел: +359 2 474 54 44

Luxembourg/Luxemburg
(Voir/siehe Belgique/Belgien)

Česká republika
Roche s. r. o.
Tel: +420 - 2 20382111

Magyarország
Roche (Magyarország) Kft.
Tel: +36 - 1 279 4500

Danmark
Roche Pharmaceuticals A/S
Tlf: +45 - 36 39 99 99

Malta
(See Ireland)

Deutschland
Roche Pharma AG
Tel: +49 (0) 7624 140

Nederland
Roche Nederland B.V.
Tel: +31 (0) 348 438050

Eesti
Roche Eesti OÜ
Tel: + 372 - 6 177 380

Norge
Roche Norge AS
Tlf: +47 - 22 78 90 00

Ελλάδα
Roche (Hellas) A.E.
Τηλ: +30 210 61 66 100

Österreich
Roche Austria GmbH
Tel: +43 (0) 1 27739

España
Roche Farma S.A.
Tel: +34 - 91 324 81 00

Polska
Roche Polska Sp.z o.o.
Tel: +48 - 22 345 18 88

France
Roche
Tél: +33 (0) 1 47 61 40 00

Portugal
Roche Farmacêutica Química, Lda
Tel: +351 - 21 425 70 00

Hrvatska

Roche d.o.o.
Tel: +385 1 4722 333

Ireland

Roche Products (Ireland) Ltd.
Tel: +353 (0) 1 469 0700

Ísland

Roche Pharmaceuticals A/S
c/o Icepharma hf
Sími: +354 540 8000

Italia

Roche S.p.A.
Tel: +39 - 039 2471

Κύπρος

Γ.Α.Σταμάτης & Σια Λτδ.
Τηλ: +357 - 22 76 62 76

Latvija

Roche Latvija SIA
Tel: +371 - 6 7039831

România

Roche România S.R.L.
Tel: +40 21 206 47 01

Slovenija

Roche farmacevtska družba d.o.o.
Tel: +386 - 1 360 26 00

Slovenská republika

Roche Slovensko, s.r.o.
Tel: +421 - 2 52638201

Suomi/Finland

Roche Oy
Puh/Tel: +358 (0) 10 554 500

Sverige

Roche AB
Tel: +46 (0) 8 726 1200

United Kingdom (Northern Ireland)

Roche Products (Ireland) Ltd.
Tel: +44 (0) 1707 366000

This leaflet was last revised in

Other sources of information

Detailed information on this medicine is available on the European Medicines Agency web site:
<http://www.ema.europa.eu>

7. Instructions for use

Transfer Needle with Filter Option (for transfer of medicine from vial to syringe)



Instructions for Use Hemlibra Injection Single-Dose Vial(s)

You must read, understand and follow the Instructions for Use before injecting Hemlibra. Your healthcare provider should show you how to prepare, measure, and inject Hemlibra properly before you use it for the first time. Ask your healthcare provider if you have any questions.

Important Information:

Do not use these instructions when using a Vial Adapter to withdraw Hemlibra from the vial. These instructions are for use with the Transfer Needle only.

- **Do not** inject yourself or someone else unless you have been shown how to by your healthcare provider.
- Make sure the name Hemlibra is on the box and vial label.
- Before opening the vial, read the vial label to make sure you have the correct medicine strength(s) to give the dose prescribed for you. You may need to use more than 1 vial to give yourself the correct dose.
- Check the expiry date on the box and vial label. **Do not** use if the expiry date has passed.
- **Only use the vial once.** After you inject your dose, throw away any unused Hemlibra left in the vial. Do not save unused medicine in the vial for later use.
- **Only use the syringes, transfer needles and injection needles that your healthcare provider prescribes.**
- **Use the syringes, transfer needles and injection needles only once. Throw away any used caps, vial(s) and syringes and needles.**
- If your prescribed dose is more than 2 mL, you will need to have more than one subcutaneous injection of Hemlibra; contact your healthcare provider for the injection instructions.
- You must inject Hemlibra only under the skin.

Storing Hemlibra vials:

- Keep the vial in the refrigerator (2°C to 8°C). **Do not** freeze.

- Keep the vial in the original box to protect the medicine from light.
- Once removed from the refrigerator, the unopened vial can be kept at room temperature (below 30°C) for up to 7 days. After storage at room temperature unopened vials may be returned to the refrigerator. The total amount of time outside cold storage and at room temperature should not exceed 7 days.
- Discard vials that have been kept at room temperature for more than 7 days or have been in temperatures above 30°C.
- Keep the vials, out of the sight and reach of children.
- Take the vial out of the refrigerator 15 minutes before use and allow it to reach room temperature (below 30°C) before preparing an injection.
- **Do not** shake the vial.

Storing needles and syringes:

- Keep the transfer needle, injection needle and syringe dry.
- Keep the transfer needle, injection needle and syringe out of the sight and reach of children.

Inspecting the medicine and your supplies:

- Collect all supplies listed below to prepare and give your injection.
- **Check** the expiry date on the box, on the vial label and on the supplies listed below. **Do not** use if the expiry date has passed.
- **Do not** use the vial if:
 - the medicine is cloudy, hazy or coloured.
 - the medicine contains particles.
 - the cap covering the stopper is missing.
- Inspect the supplies for damage. Do not use if they appear damaged or if they have been dropped.
- Place the supplies on a clean, well-lit flat work surface.

Included in the box:

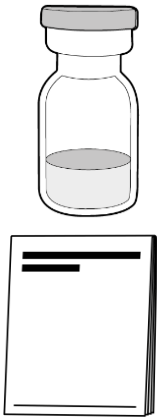

- **Vial containing the medicine**
- **Hemlibra Instructions for Use**

Not included in the box:

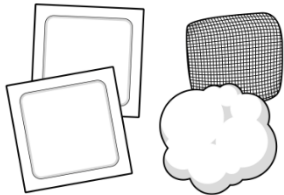

- **Alcohol wipes**
Note: If you need to use more than 1 vial to inject your prescribed dose, you must use a new alcohol wipe for each vial.
- **Gauze**
- **Cotton ball**

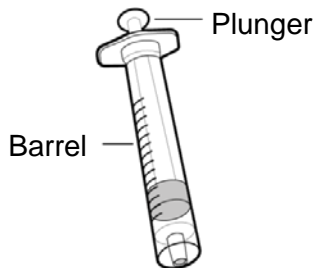

- **Syringe**
- For injection amount up to 1 mL use a **1 mL syringe**.
- For injection amount between 1 mL and 2 mL use a **2 mL or 3 mL syringe**.
- **Note: Do not** use 2 or 3 mL syringe for doses up to 1 mL.

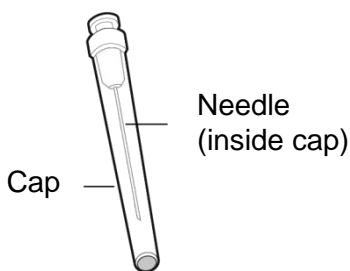

- **18G Transfer needle with 5 micrometre filter**
Note: If you need to use more than 1 vial to inject your prescribed dose, you must use a new transfer needle for each vial.
- **Do not** use the transfer needle to inject the medicine.

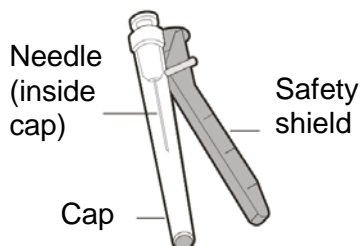

- Injection needle with safety shield (Used to inject medicine).
- **Do not** use the injection needle to withdraw medicine from vial.



- **Sharps disposal container**

Get ready:

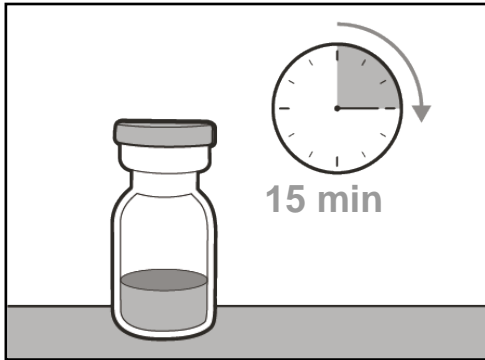

- Before use, allow the vial(s) to reach room temperature for about 15 minutes on a clean flat surface away from direct sunlight.
- **Do not** try to warm the vial by any other way.
-
- **Wash your hands** well with soap and water.

Selecting and preparing an injection site:

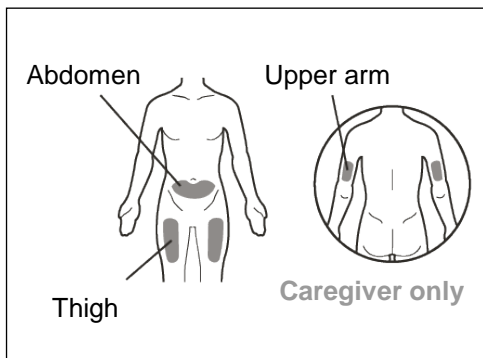

- Clean the chosen injection site area using an alcohol wipe.
- Let the skin dry for about 10 seconds.
- **Do not** touch, fan or blow on the cleaned area before your injection.

For your injection, you can use your:

- Thigh (front and middle).
- Stomach area (abdomen), except for the 5 cm around the navel (belly button).
- Outer area of the upper arm (only if a caregiver is giving the injection).
- You should use a different injection site for each injection, at least 2.5 cm away from the area you used for any previous injection.
- **Do not** inject into areas that could be irritated by a belt or waistband.
- **Do not** inject into moles, scars, bruises, or areas where the skin is tender, red, hard or the skin is broken.

Preparing the syringe for injection:

- Once the syringe has been filled with the medicine, the injection must be given immediately.
- Once the injection needle cap has been removed, the medicine in the syringe must be injected under the skin within 5 minutes.
- **Do not** touch exposed needles or place them on a surface once the cap has been removed.
- **Do not** use the syringe if the needle touches any surface.

Important information after the injection:

- **If you see drops of blood at the injection site, you can press a sterile cotton ball or gauze over the injection site for at least 10 seconds, until bleeding has stopped.**
- If you have bruising (small area of bleeding under the skin), an ice pack can also be pressed gently on the site. If bleeding does not stop, please contact your healthcare provider.
- **Do not** rub the injection site after injection.

Disposing of the medicine and supplies:

Important: Always keep the sharps disposal container out of reach of children.

- **Throw away any used caps, vial(s), needles and syringes in a sharps or puncture-proof container.** Put your used needles and syringes in a sharps disposal container straight away after use. **Do not** throw away any loose caps, vials, needles and syringes in your household waste.
- If you do not have a sharps disposal container, you may use a household container that is:
 - made of heavy-duty plastic.
 - can be closed with a tight-fitting, puncture resistant lid, without sharps being able to come out.
 - upright and stable during use.
 - leak-resistant.
 - properly labelled to warn of hazardous waste inside the container.
- When your sharps disposal container is almost full, you will need to follow your local guidelines for the right way to throw away of your sharps disposal container.
- **Do not** throw away any used sharps disposal container in your household waste unless your local guidelines permit this. **Do not** recycle your used sharps disposal container.

1. PREPARATION

Step 1. Remove vial cap and clean top



- Take the cap off the vial(s).
- Throw away the vial cap(s) into the sharps disposal container.

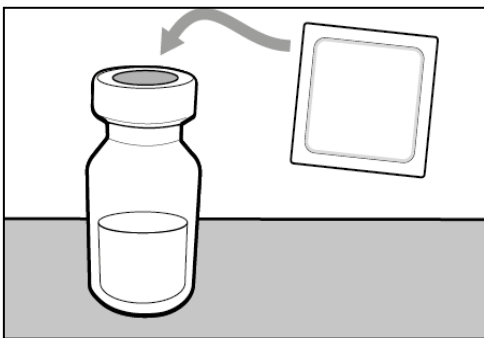

- Clean the top of the vial(s) stopper with an alcohol wipe.

Step 2. Attach transfer needle with filter to syringe

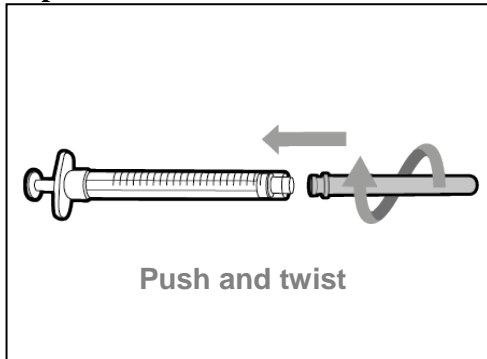

- **Push and twist the transfer needle with filter clockwise** on to the syringe until it is fully attached.

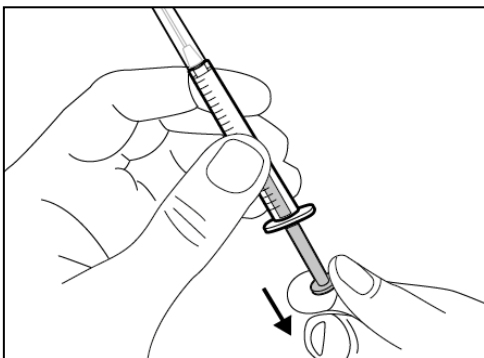

- Slowly pull back on the plunger and draw air into the syringe that is the same amount as your prescribed dose.

Step 3. Uncap transfer needle

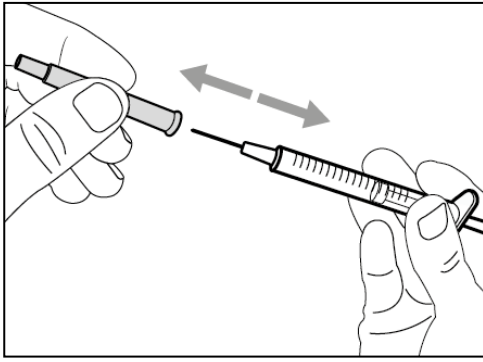

- Hold the syringe by the barrel with the transfer needle pointing up.
- Carefully pull the transfer needle cap straight off and away from your body. **Do not throw the cap away. Place the transfer needle cap down on a clean flat surface.** You will need to recap the transfer needle after transferring the medicine.
- **Do not** touch the needle tip or place it on a surface after the needle cap has been removed.

Step 4. Inject air into vial

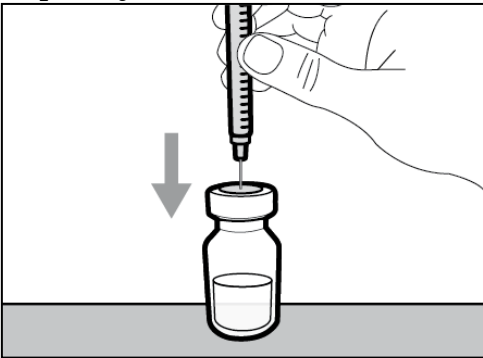

- Keep the vial on the flat working surface and insert the transfer needle and syringe straight down into the centre of the vial stopper.

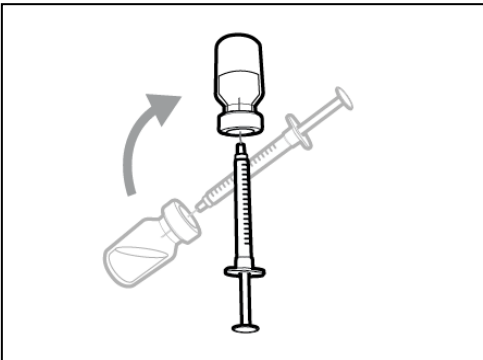

- Keep the needle in the vial and turn the vial upside down.

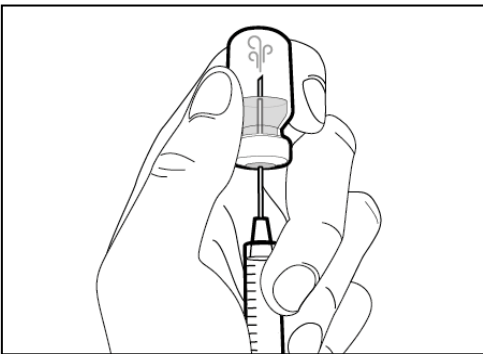

- With the needle pointing upwards, push on the plunger to inject the air from the syringe **above the medicine.**
- Keep your finger pressed down on the syringe plunger.
- **Do not** inject air into the medicine as this could create air bubbles or foam in the medicine.

Step 5. Transfer medicine to syringe

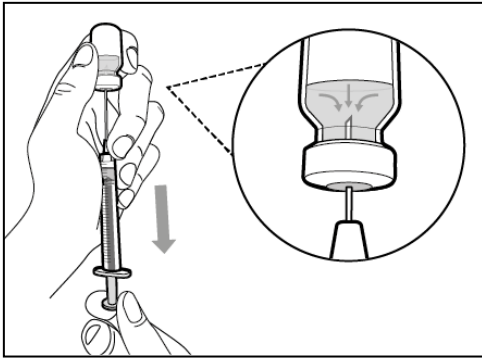

- Slide the tip of the needle down so that it is **within the medicine**.
- With the syringe pointing upwards, slowly pull back the plunger to **fill the syringe with** more than the amount of **medicine** needed for your prescribed dose.
- **Hold the plunger firmly** to ensure it does not pull back in
- Be careful not to pull the plunger out of the syringe.

Important: If your prescribed dose is more than the amount of Hemlibra in the vial, **withdraw all medicine** and go to the “**Combining Vials**” section now.

Step 6. Remove air bubbles

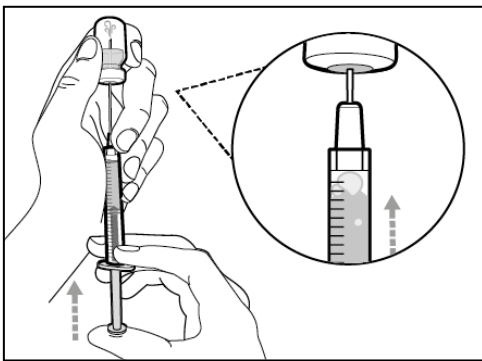

- Keep the needle in the vial and check the syringe for larger air bubbles. Large air bubbles can reduce the dose you receive.

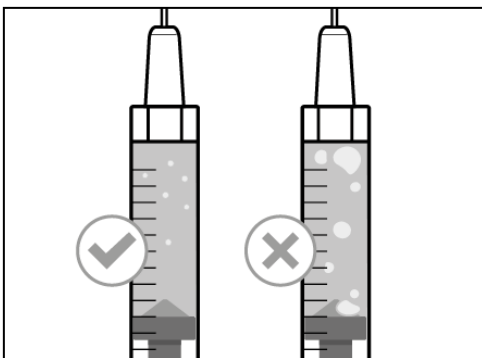

- **Remove the larger air bubbles** by gently **tapping** the syringe barrel with your fingers until the air bubbles rise to the top of the syringe. Move the tip of the needle **above the medicine** and slowly push the plunger up to push the air bubbles out of the syringe.
- If the amount of medicine in the syringe is now at or below your prescribed dose, move the tip of the needle to **within the medicine** and slowly pull back the plunger until you have **more** than the amount of medicine needed for your **prescribed dose**.
- Be careful not to pull the plunger out of the syringe.
- Repeat the steps above until you have removed the larger air bubbles.

Note: Ensure you have enough medicine in the syringe to complete your dose before moving onto the next step. If you cannot remove all medicine, turn the vial upright to reach the remaining amount.

⚠ Do not use the transfer needle to inject medicine as this may cause pain and bleeding.

2. INJECTION

Step 7. Recap transfer needle

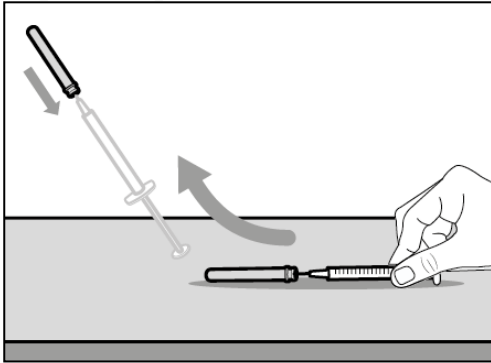

- Remove the syringe and transfer needle from the vial.
- **Using one hand, slide** the transfer needle into the cap and **scoop upwards** to cover the needle.
- Once the needle is covered, push the transfer needle cap towards the syringe to fully attach it with **one hand** to prevent accidentally injuring yourself with the needle

Step 8. Clean injection site

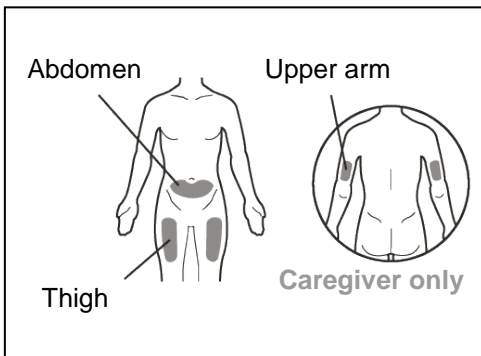

- Select and **clean** your injection site with an alcohol wipe.

Step 9. Remove the used transfer needle from the syringe

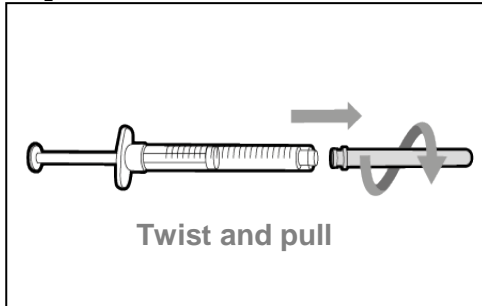

- Remove the used transfer needle from the syringe by twisting anticlockwise and gently pulling.
- Throw away the used transfer needle into a sharps disposal container.

Step 10. Attach injection needle to syringe

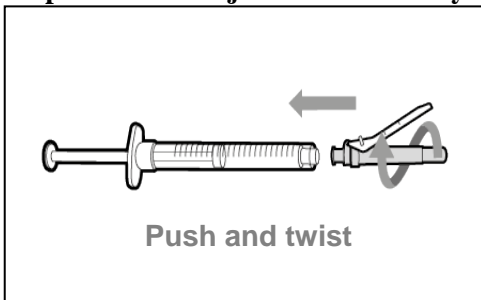

- Push and twist the injection needle clockwise onto the syringe until it is fully attached.

Step 11. Move safety shield

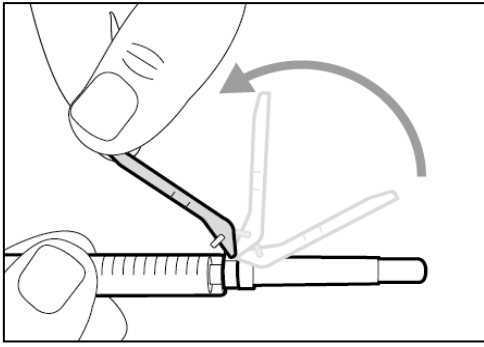

- Move the safety shield away from the needle and **towards** the syringe barrel.

Step 12. Uncap injection needle

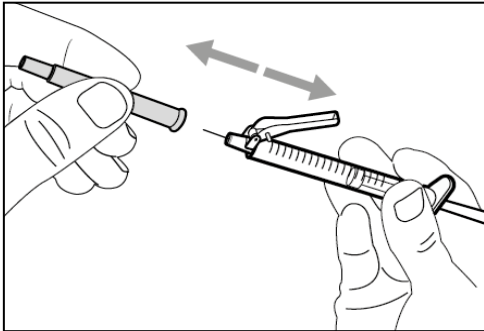

- **Carefully** pull the injection needle cap **straightaway** from the syringe.
- Throw away the cap into a sharps disposal container.
- Do not touch the needle tip or allow it to touch any surface.
- After the injection needle cap has been removed, the medicine in the syringe must be injected within 5 minutes.

Step 13. Adjust plunger to prescribed dose

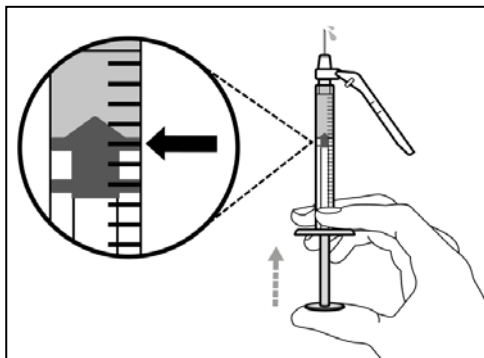

- Hold the syringe with the needle pointing up and slowly push the plunger to your prescribed dose.
- **Check your dose**, ensure the top rim of the plunger is in line with the mark on the syringe for your prescribed dose.

Step 14. Subcutaneous (under the skin) injection

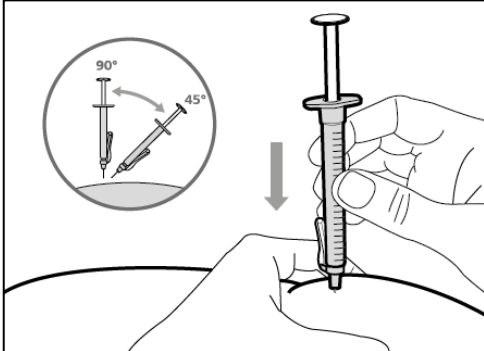

- Pinch the selected injection site and fully insert the needle at a **45° to 90° angle** with a quick, firm action. **Do not** hold or push on the plunger while inserting the needle.
- Hold the position of the syringe and let go of the pinched injection site.

Step 15. Inject the medicine

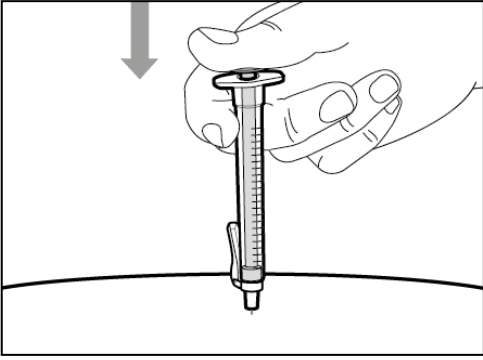

- Slowly inject all of the medicine by gently pushing the plunger all the way down.
- Remove the needle and syringe from the injection site at the same angle as inserted.

3. DISPOSAL

Step 16. Cover needle with safety shield

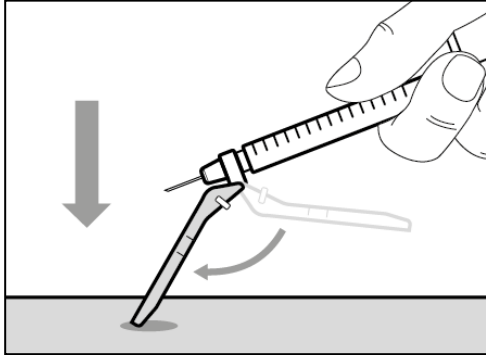

- Move the safety shield forward 90°, away from the syringe barrel.
- **Holding the syringe with one hand, press the safety shield down** against a flat surface with a firm, quick motion until you hear a “click”.

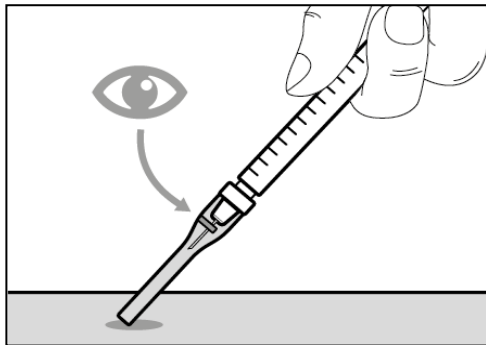

- If you do not hear a click, look to see that the needle is fully covered by the safety shield.
- Keep your fingers behind the safety shield and away from the needle at all times.
- **Do not** detach the injection needle.

Step 17. Throw away the syringe and needle

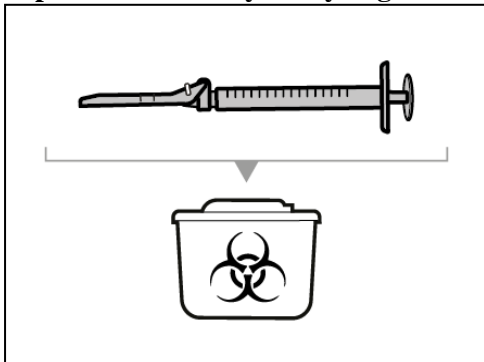

- Put your used needles and syringes in a sharps disposal container right away after use. For further information refer to the section “Disposing of the medicine and supplies”.
- **Do not** try to remove the used injection needle from the used syringe.
- **Do not** recap the injection needle with the cap.
- **Important:** Always keep the sharps disposal container out of reach of children.
- Throw away any used caps, vial(s), needles and syringes in a sharps or puncture-proof container

Combining Vials

If you need to use more than 1 vial to get to your prescribed dose, follow these steps after you have drawn up the medicine from the first vial as described in step 5. You must use a new transfer needle for each vial.

Step A. Recap transfer needle

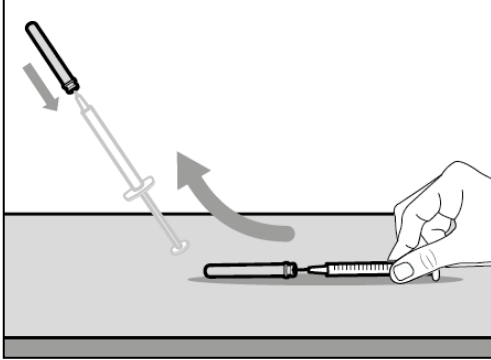

- Remove the syringe and transfer needle from the vial.
- **Using one hand, slide** the transfer needle into the cap and **scoop upwards** to cover the needle.
- Once the needle is covered, push the transfer needle cap towards the syringe to fully attach it with **one hand** to prevent accidentally injuring yourself with the needle

Step B. Remove the used transfer needle from the syringe

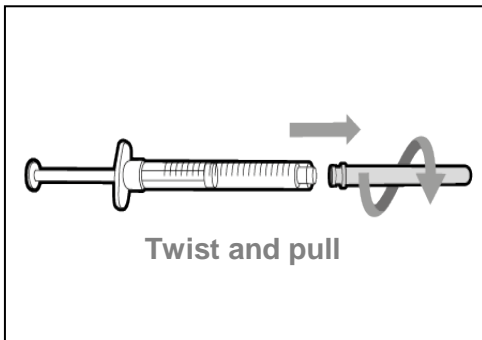

- Remove the used transfer needle from the syringe by twisting anticlockwise and gently pulling.
- Throw away the used transfer needle into a sharps disposal container.

Step C. Attach a new transfer needle with filter to the syringe

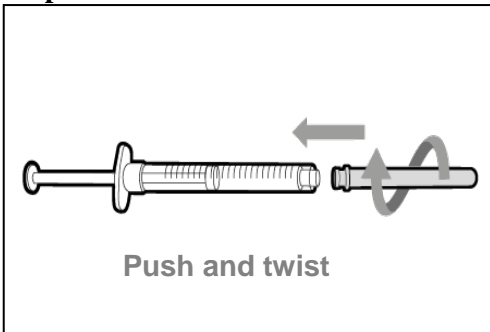

- Push and twist a new transfer needle clockwise onto the syringe until it is fully attached.
- Slowly pull back the plunger and draw some air into the syringe.

Step D. Uncap transfer needle

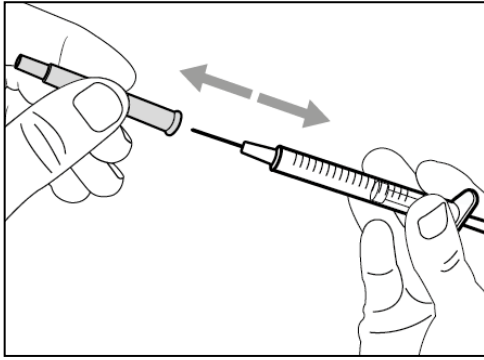

- Hold the syringe by the barrel with the transfer needle pointing up.
- Carefully pull the transfer needle cap straight off and away from your body. **Do not throw the cap away.** You will need to recap the transfer needle after transferring the medicine.
- **Do not** touch the needle tip.

Step E. Inject air into vial

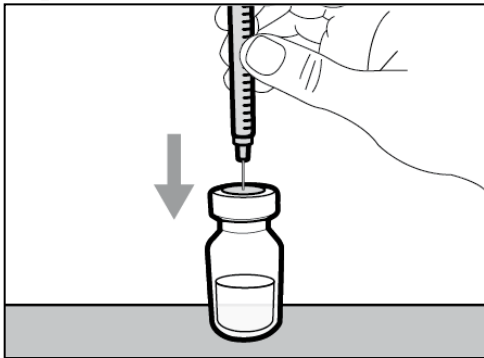

- With the new vial on the flat working surface, insert the new transfer needle and syringe, straight down into the centre of the vial stopper.

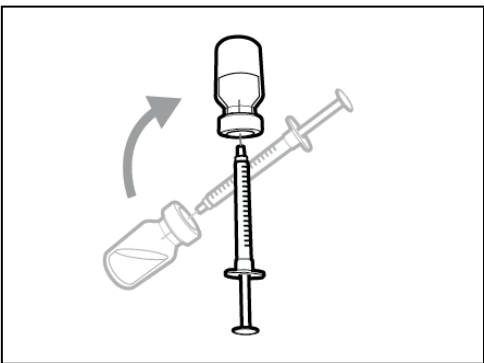

- Keep the needle in the vial and turn the vial upside down.

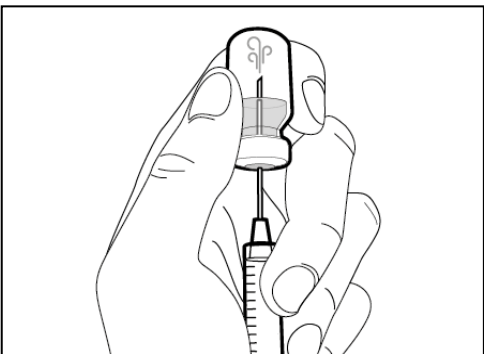

- With the needle pointing upwards, push on the plunger to inject the air from the syringe **above the medicine.**
- Keep your finger pressed down on the syringe plunger.
- **Do not** inject air into the medicine as this could create air bubbles or foam in the medicine.

Step F. Transfer medicine to syringe

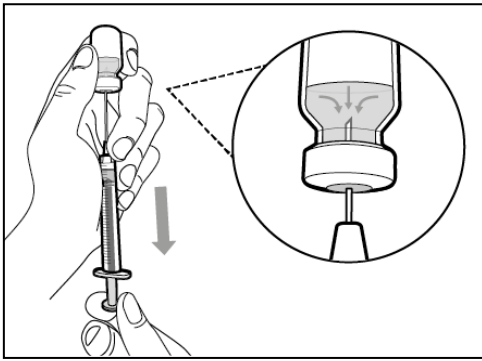

- Slide the tip of the needle down so that it is **within the medicine**.
- With the syringe pointing upwards, slowly pull back the plunger to **fill the syringe with** more than the amount **of medicine** needed for your prescribed dose.
- **Hold the plunger firmly** to ensure it does not pull back in
- Be careful not to pull the plunger out of the syringe.

Note: Ensure you have enough medicine in the syringe to complete your dose before moving onto the next steps. If you cannot remove all medicine, turn the vial upright to reach the remaining amount.

! Do not use the transfer needle to inject medicine as this may cause pain and bleeding.

Repeat steps A to F with each additional vial until you have more than the amount of medicine needed for your prescribed dose. Once completed, keep the transfer needle inserted in the vial and return to Step 6 “Remove air bubbles”. Continue with the remaining steps.

Vial adapter with Filter
Option
(for transfer of medicine from vial to syringe)



Instructions for Use
Hemlibra
Injection
Single-Dose Vial(s)

You must read, understand and follow the Instructions for Use before injecting Hemlibra. Your healthcare provider should show you how to prepare, measure, and inject Hemlibra properly before you use it for the first time. Ask your healthcare provider if you have any questions.

Important Information:

Do not use these instructions when using a transfer needle to withdraw Hemlibra from the vial. These instructions are for use with the Vial Adapter only.

- **Do not** inject yourself or someone else unless you have been shown how to by your healthcare provider.
- Make sure the name Hemlibra is on the box and vial label.
- Before opening the vial, read the vial label to make sure you have the correct medicine strength(s) to give the dose prescribed for you. You may need to use more than 1 vial to give yourself the correct dose.
- Check the expiry date on the box and vial label. **Do not** use if the expiry date has passed
- **Only use the vial once.** After you inject your dose, throw away any unused Hemlibra left in the vial. **Do not** save unused medicine in the vial for later use.
- **Only use the syringes, vial adapters, and injection needles that your healthcare provider prescribes.**
- **Use the syringes, vial adapters and injection needles only once. Throw away any used caps, vial(s) and syringes and needles.**
- If your prescribed dose is more than 2 mL, you will need to have more than one subcutaneous injection of Hemlibra; contact your healthcare provider for the injection instructions.
- You must inject Hemlibra only under the skin.

Storing Hemlibra vials:

- Store the vial in the refrigerator (2°C to 8°C). **Do not** freeze.
- Keep the vial in the original box to protect the medicine from light.

- Once removed from the refrigerator, the unopened vial can be kept at room temperature (below 30°C) for up to 7 days. After storage at room temperature unopened vials may be returned to the refrigerator. The total amount of time outside cold storage and at room temperature should not exceed 7 days.
- Discard vials that have been kept at room temperature for more than 7 days or have been in temperatures above 30°C.
- Keep vials out of the sight and reach of children.
- Take the vial out of the refrigerator 15 minutes before use and allow it to reach room temperature (below 30°C) before preparing an injection.
- **Do not** shake the vial.

Storing vial adapters, needles and syringes:

- Keep the vial adapter, injection needle and syringe dry.
- Keep the vial adapter, injection needle and syringe out of the sight and reach of children

Inspecting the medicine and your supplies:

- Collect all supplies listed below to prepare and give your injection.
- **Check** the expiry date on the box, on the vial label, and on the supplies listed below. **Do not** use if the expiry date has passed.
- **Do not** use the vial if:
 - the medicine is cloudy, hazy or coloured.
 - the medicine contains particles.
 - the cap covering the stopper is missing.
- Inspect the supplies for damage. **Do not** use if they appear damaged or if they have been dropped.
- Place the supplies on a clean, well-lit flat work surface.

Included in the box:



- **Vial containing the medicine**



- **Hemlibra Instructions for Use**

Not included in the box:

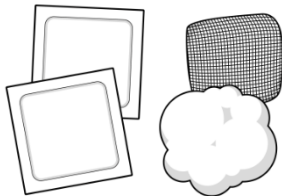

- **Alcohol wipes**
Note: If you need to use more than 1 vial to inject your prescribed dose, you must use a new alcohol wipe for each vial.

- **Gauze**
- **Cotton ball**

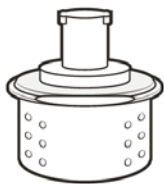

- **Vial adapter with filter** (To be added on top of vial).

Note: Used for withdrawing medicine from the vial to the syringe. If you need to use more than 1 vial to inject your prescribed dose, you must use a new vial adapter for each vial.

- ⚠ **Do not insert injection needle into vial adapter.**

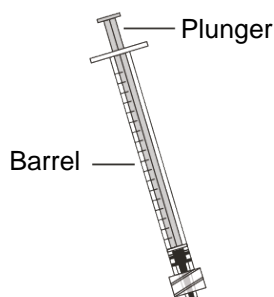

- **Syringe with Low Dead Space (LDS) Plunger**
Important:

- For injection amount up to 1 mL use **1 mL LDS syringe**
- For injection amount over 1 mL use **2 or 3 mL LDS syringes.**

Note: Do not use 2 or 3 mL LDS syringes for doses up to 1 mL

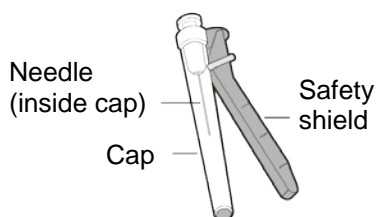

- Injection needle with safety shield (Used to inject medicine).
- **Do not** insert the injection needle into vial adapter or use the injection needle to withdraw medicine from vial.

- **Sharps disposal container**



Get ready:

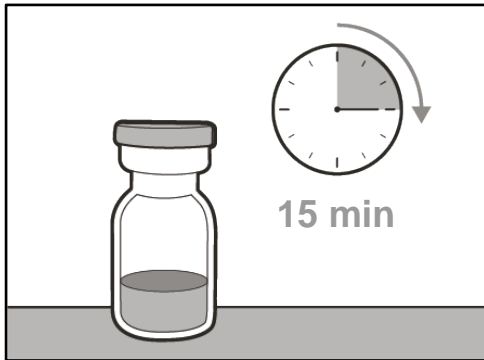

- Before use, allow the vial(s) to reach room temperature for about 15 minutes on a clean flat surface away from direct sunlight.
- **Do not** try to warm the vial by any other way.
- **Wash your hands** well with soap and water.

Selecting and preparing an injection site:

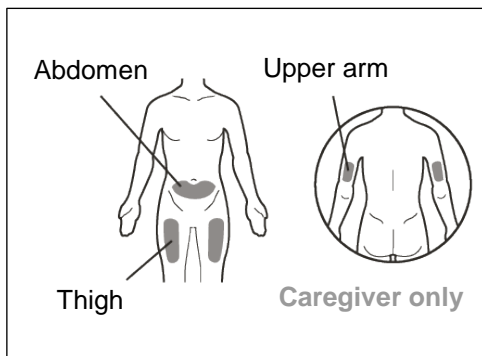

- Clean the chosen injection site area using an alcohol wipe.
- Let the skin dry for about 10 seconds.
- **Do not** touch, fan or blow on the cleaned area before your injection.

For your injection, you can use your:

- Thigh (front and middle).
- Stomach area (abdomen), except for the 5 cm around the navel (belly button).
- Outer area of the upper arm (only if a caregiver is giving the injection).
- You should use a different injection site for each injection, at least 2.5 cm away from the area you used for any previous injection.
- **Do not** inject into areas that could be irritated by a belt or waistband.
- **Do not** inject into moles, scars, bruises, or areas where the skin is tender, red, hard or the skin is broken.

Preparing the syringe for injection:

- Once the syringe has been filled with the medicine, the injection must be given immediately.
- Once the injection needle cap has been removed, the medicine in the syringe must be injected under the skin within 5 minutes.

- **Do not** touch exposed needles or place them on a surface once the cap has been removed.
- **Do not** use the syringe if the needle touches any surface.

Important information after the injection:

- **If you see drops of blood at the injection site, you can press a sterile cotton ball or gauze over the injection site for at least 10 seconds, until bleeding has stopped.**
- If you have bruising (small area of bleeding under the skin), an ice pack can also be pressed gently on the site. If bleeding does not stop, please contact your healthcare provider.
- **Do not** rub the injection site after injection.

Disposing of the medicine and supplies:

Important: Always keep the sharps disposal container out of reach of children.

- **Throw away any used caps, vial(s), vial adapters, needles and syringes in a sharps or puncture-proof container.**
- Put your used vial adapters, needles and syringes in a sharps disposal container straight away after use. **Do not** throw away any loose caps, vials, needles and syringes in your household waste.
- If you do not have a sharps disposal container, you may use a household container that is:
 - made of heavy-duty plastic.
 - can be closed with a tight-fitting, puncture resistant lid, without sharps being able to come out.
 - upright and stable during use.
 - leak-resistant.
 - properly labelled to warn of hazardous waste inside the container.
- When your sharps disposal container is almost full, you will need to follow your local guidelines for the right way to throw away of your sharps disposal container.
- **Do not** throw away any used sharps disposal container in your household waste unless your local guidelines permit this. **Do not** recycle your used sharps disposal container.

1. PREPARATION

Step 1. Remove vial cap and clean top



- Take the cap off the vial(s).
- Throw away the vial cap(s) into the sharps disposal container.

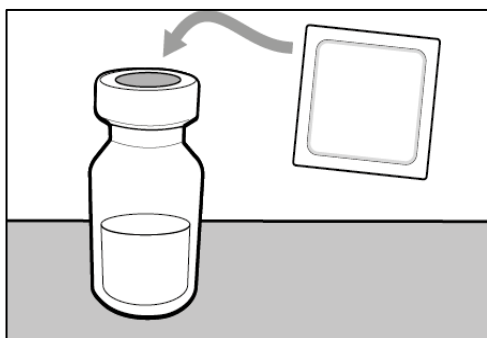

- Clean the top of the vial(s) stopper with an alcohol wipe.

Step 2. Insert vial adapter onto vial

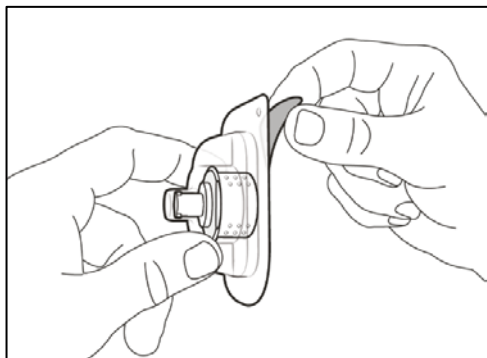

- Peel off back to open the blister pack.
- ⚠ **Do not** remove the vial adapter from the clear plastic blister pack.

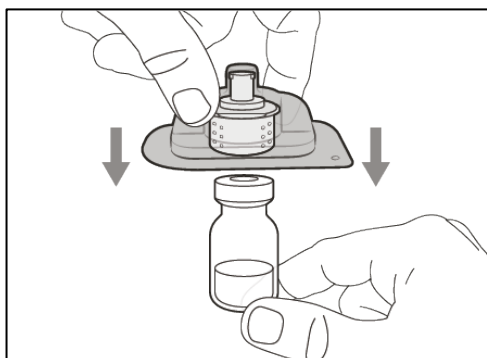

- Firmly press down the plastic blister pack with the vial adapter onto the new vial, until you hear a “click”.

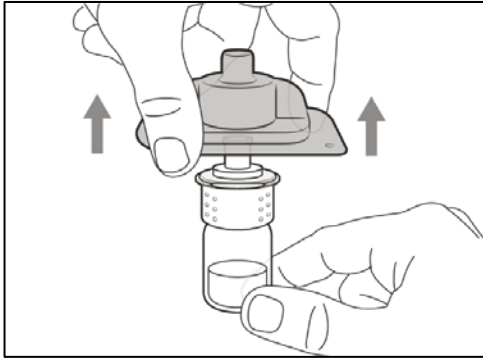

- Remove and throw away the plastic blister pack.
- **Do not** touch the tip of vial adapter.

Step 3. Connect syringe to vial adapter

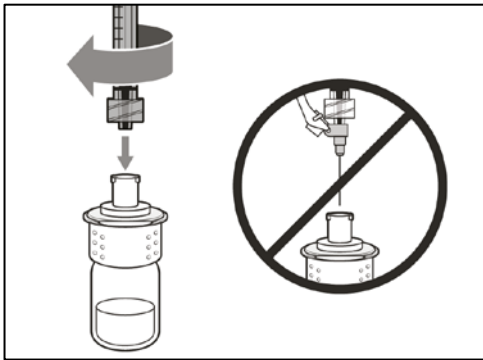

- **Remove syringe cap** (if required).
- **Push and twist the syringe clockwise** on to the vial adapter until it is fully attached.

Step 4. Transfer medicine to syringe

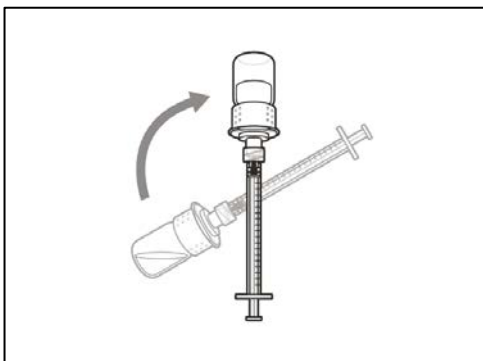

- Keep the vial adapter attached to the syringe and turn the vial upside down.

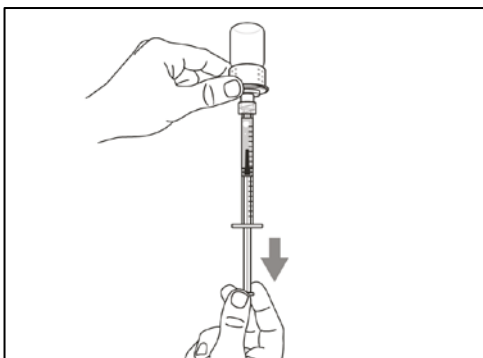

- With the syringe pointing upwards, slowly pull back the plunger to **fill the syringe with** more than the amount of **medicine** needed for your prescribed dose.
- **Hold plunger firmly** to ensure it does not pull back in.
- Be careful not to pull the plunger out of the syringe.

Important: If your prescribed dose is more than the amount of Hemlibra in the vial, **withdraw all medicine** and go to the “**Combining Vials**” section now.

Step 5. Remove air bubbles

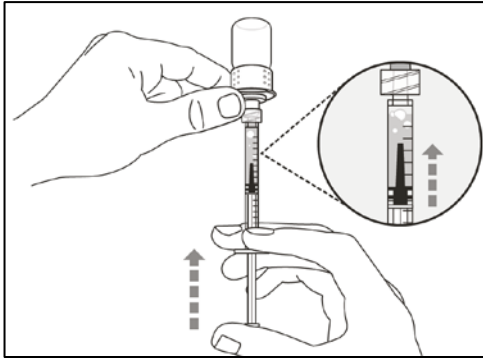

- Keep the vial attached to the syringe and **check the syringe for larger air bubbles**. Large air bubbles can reduce the dose you receive.

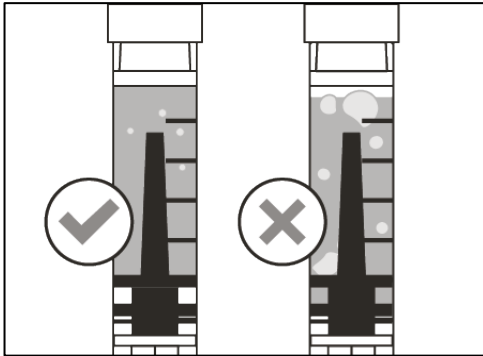

- **Remove the larger air bubbles** by gently **tapping** the syringe barrel with your finger until the air bubbles rise to the top of the syringe. **Slowly push the plunger** to push the large air bubbles out of the syringe.
- If the amount of medicine in the syringe is now at or below your prescribed dose, slowly pull back the plunger until you have **more** than the amount of medicine needed for your **prescribed dose**.
- Be careful not to pull the plunger out of the syringe.
- Repeat the steps above until you have removed the large air bubbles.

Note: Ensure you have enough medicine in the syringe to complete your dose before moving on to the next step.

2. INJECTION

Step 6. Clean injection site

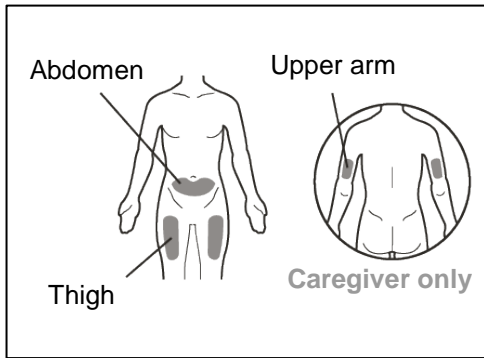

- Select and **clean** your injection site with an alcohol wipe.

Step 7. Remove syringe from vial adapter

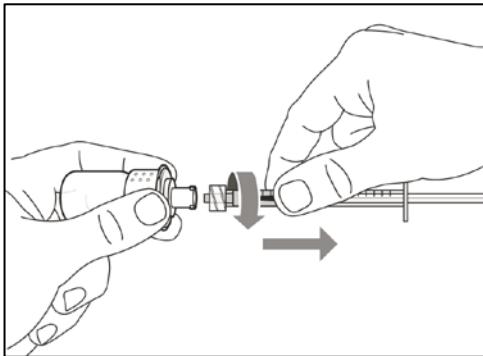

- Remove the syringe from the vial adapter by twisting anticlockwise and gently pulling.
- Throw away the used vial/vial adapter into a sharps disposal container.

Step 8. Attach injection needle to syringe

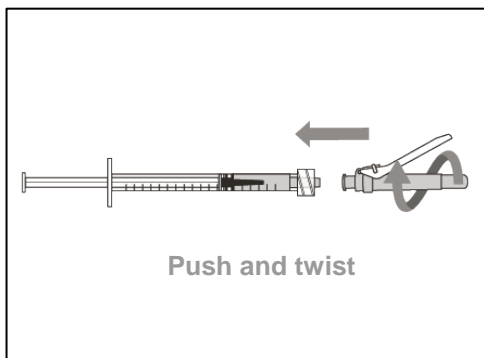

- Push and twist the injection needle clockwise onto the syringe until it is fully attached.
- **Do not** insert the injection needle into vial adapter or use the injection needle to withdraw medicine from vial.

Step 9. Move safety shield

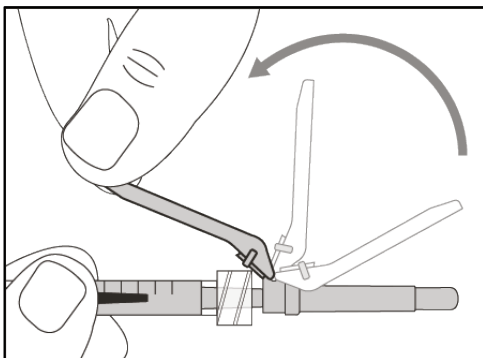

- Move the safety shield away from the needle and **towards** the syringe barrel.

Step 10. Uncap injection needle

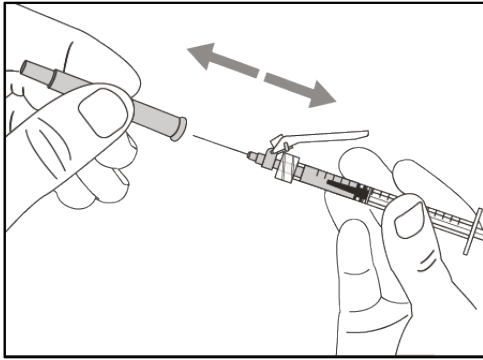

- **Carefully** pull the injection needle cap **straightaway** from the syringe.
- Throw away the cap into a sharps disposal container.
- **Do not** touch the needle tip or allow it to touch any surface.
- After the injection needle cap has been removed, the medicine in the syringe must be injected within 5 minutes.

Step 11. Adjust plunger to prescribed dose

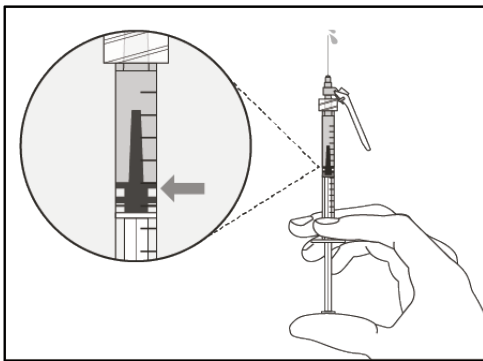

- Hold the syringe with the needle pointing up and slowly push the plunger to your prescribed dose.
- **Check your dose**, ensure the top rim of the plunger is in line with the mark on the syringe for your prescribed dose.

Step 12. Subcutaneous (under the skin) injection

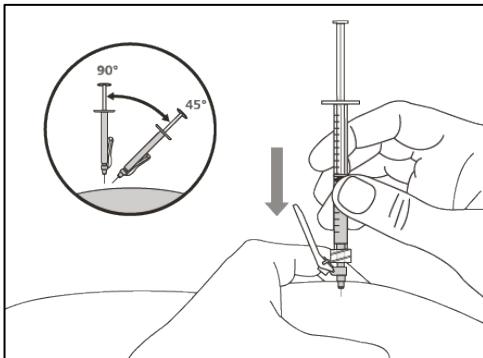

- Pinch the selected injection site and fully insert the needle at a **45° to 90°** angle with a quick, firm action. **Do not** hold or push on the plunger while inserting the needle.
- Hold the position of the syringe and let go of the pinched injection site.

Step 13. Inject the medicine

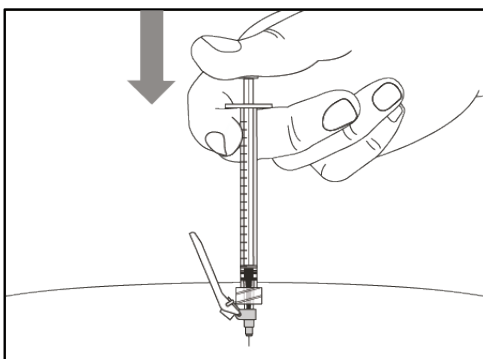

- Slowly inject all of the medicine by gently pushing the plunger all the way down.
- Remove the needle and syringe from the injection site at the same angle as inserted.

3. DISPOSAL

Step 14. Cover needle with safety shield

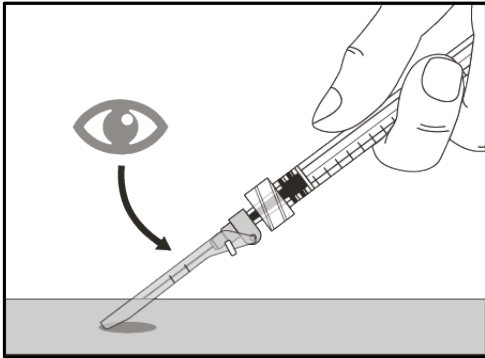
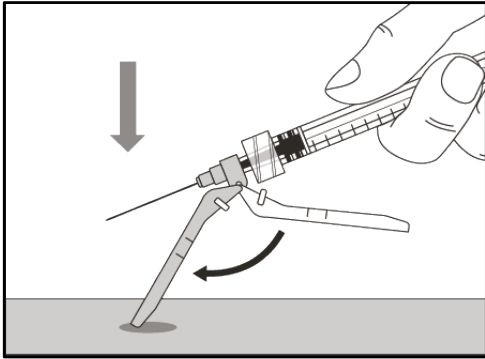

- Move the safety shield forward 90°, away from the syringe barrel.
- **Holding the syringe with one hand, press the safety shield down** against a flat surface with a firm, quick motion until you hear a “click”.
- If you do not hear a click, look to see that the needle is fully covered by the safety shield.
- Keep your fingers behind the safety shield and away from the needle at all times.
- **Do not** detach the injection needle.

Step 15. Throw away the needle and syringe

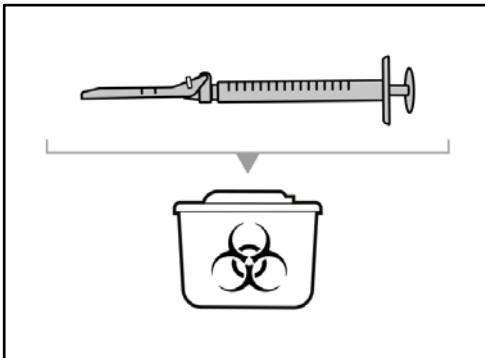

- Put your used needles and syringes in a sharps disposal container right away after use. For further information refer to the section “Disposing of the medicine and supplies”.
- **Do not** try to remove the used injection needle from the used syringe.
- **Do not** recap the injection needle with the cap.
- **Important:** Always keep the sharps disposal container out of reach of children.
- Throw away any used caps, vial(s), vial adapters, needles and syringes in a sharps or puncture-proof container.

Combining Vials

If you need to use more than 1 vial to get to your prescribed dose, follow these steps after you have drawn up the medicine from the first vial as described in step 4. You must use a new vial adapter for each vial.

Step A. Insert new vial adapter into new vial

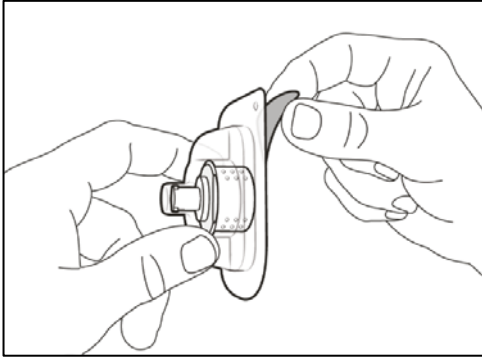

- Peel off back to open the blister pack.
- ⚠ **Do not** remove the vial adapter from the clear plastic blister pack.

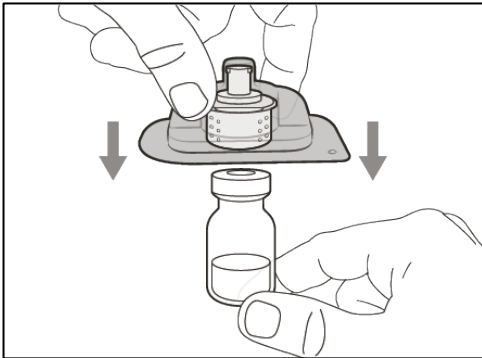

- Firmly press down the plastic blister pack with the vial adapter onto the new vial, until you hear a “click”.

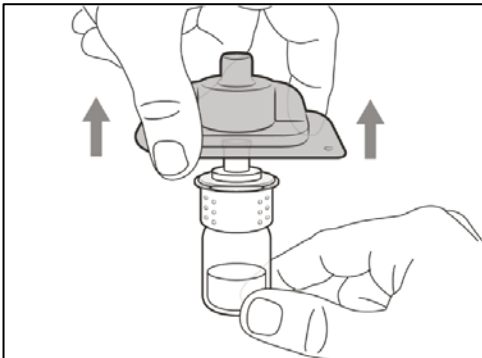

- Remove and throw away the plastic blister pack.
- **Do not** touch the tip of vial adapter.

Step B. Remove syringe from used vial adapter

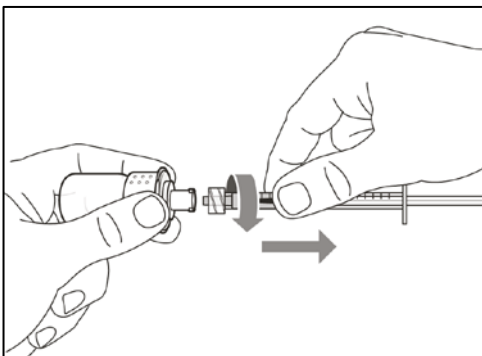

- Remove the syringe from the used vial adapter by twisting anticlockwise and gently pulling.
- Throw away the used vial/vial adapter into a sharps disposal container.

Step C. Connect syringe to new vial adapter

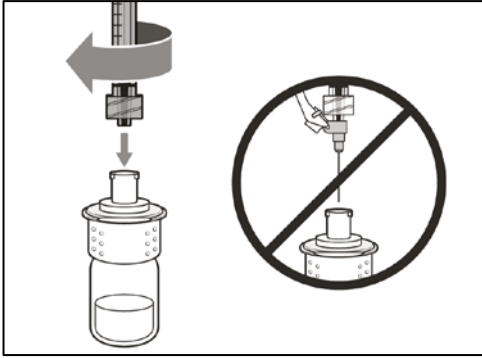

- **Push and twist the same syringe clockwise** on to the next vial adapter until it is fully attached.

Step D. Transfer medicine into syringe

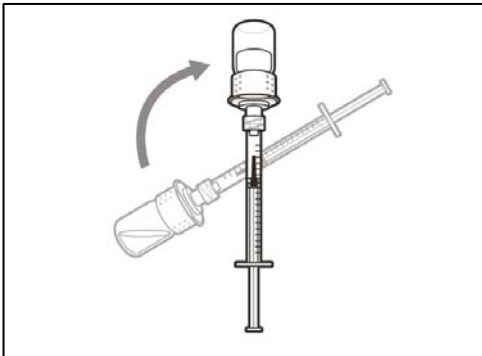

- Keep the vial adapter attached to the syringe and turn the vial upside down.

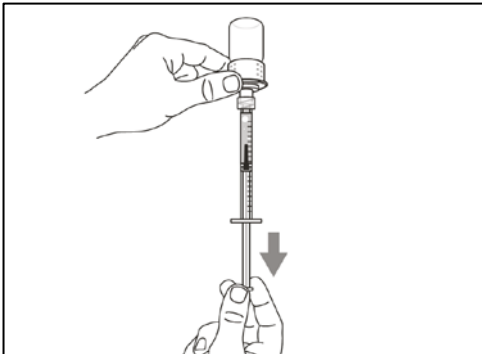

- With the syringe pointing upwards, slowly pull back the plunger to **fill the syringe with** more than the amount **of the medicine** needed for your prescribed dose.
- **Hold plunger firmly** to ensure it does not pull back in.
- Be careful not to pull the plunger out of the syringe.

Note: Ensure you have enough medicine in the syringe to complete your dose before moving on to the next step.

Repeat steps A to D with each additional vial until you have more than the amount of medicine needed for your prescribed dose. Once completed, keep the vial adapter onto the vial and return to Step 5 “Remove air bubbles”. Continue with the remaining steps.