

ANNEX I
SUMMARY OF PRODUCT CHARACTERISTICS

▼ This medicinal product is subject to additional monitoring. This will allow quick identification of new safety information. Healthcare professionals are asked to report any suspected adverse reactions. See section 4.8 for how to report adverse reactions.

1. NAME OF THE MEDICINAL PRODUCT

Evrysdi 0.75 mg/mL powder for oral solution

2. QUALITATIVE AND QUANTITATIVE COMPOSITION

Each bottle contains 60 mg risdiplam in 2 g powder for oral solution.

Each mL of the constituted solution contains 0.75 mg risdiplam.

Excipients with known effects

Each mL contains 0.38 mg of sodium benzoate (E 211) and 2.97 mg of isomalt (E 953).

For the full list of excipients, see section 6.1.

3. PHARMACEUTICAL FORM

Powder for oral solution. Light yellow, yellow, greyish yellow, greenish yellow, or light green powder.

4. CLINICAL PARTICULARS

4.1 Therapeutic indications

Evrysdi is indicated for the treatment of 5q spinal muscular atrophy (SMA) in patients with a clinical diagnosis of SMA Type 1, Type 2 or Type 3 or with one to four *SMN2* copies.

4.2 Posology and method of administration

Treatment with Evrysdi should be initiated by a physician with experience in the management of SMA.

Posology

The recommended once daily dose of Evrysdi is determined by age and body weight (see Table 1). Evrysdi is taken orally once a day after a meal at approximately the same time each day.

Table 1. Dosing regimen by age and body weight

<i>Age* and body weight</i>	<i>Recommended daily dose</i>
< 2 months of age	0.15 mg/kg
2 months to < 2 years of age	0.20 mg/kg
≥ 2 years of age (< 20 kg)	0.25 mg/kg
≥ 2 years of age (≥ 20 kg)	5 mg

* based on corrected age for preterm infants

Treatment with a daily dose above 5 mg has not been studied.

Delayed or missed doses

If a planned dose is missed, it should be administered as soon as possible if still within 6 hours of the scheduled dose. Otherwise, the missed dose should be skipped and the next dose should be administered at the regularly scheduled time the next day.

If a dose is not fully swallowed or vomiting occurs after taking a dose of Evrysdi, another dose should not be administered to make up for the incomplete dose. The next dose should be administered at the regularly scheduled time.

Elderly

No dose adjustment is required in elderly patients based on limited data in subjects aged 65 years and older (see section 5.2).

Renal impairment

Risdiplam has not been studied in this population. No dose adjustment is expected to be required in patients with renal impairment (see section 5.2).

Hepatic impairment

No dose adjustment is required in patients with mild or moderate hepatic impairment. Patients with severe hepatic impairment have not been studied and may have increased risdiplam exposure (see sections 5.1 and 5.2).

Paediatric population

Use of Evrysdi for SMA in patients 2 months of age and younger is supported by pharmacokinetic and safety data from paediatric patients 16 days and older (see sections 4.8, 5.1 and 5.2). No data on risdiplam pharmacokinetics are available in patients less than 16 days of age.

Method of administration

Oral use.

Evrysdi must be constituted by a healthcare professional (e.g. pharmacist) prior to being dispensed. It is recommended that a healthcare professional (HCP) discuss with the patient or caregiver how to prepare the prescribed daily dose prior to administration of the first dose.

Evrysdi is taken orally once a day after a meal at approximately the same time each day, using the re-usable oral syringe provided. In infants who are breastfed, Evrysdi should be administered after breastfeeding. Evrysdi should not be mixed with milk or formula milk.

Evrysdi should be taken immediately after it is drawn up into the oral syringe. If it is not taken within 5 minutes, it should be discarded from the oral syringe and a new dose be prepared. If Evrysdi spills or gets on the skin, the area should be washed with soap and water.

The patient should drink water after taking Evrysdi to ensure the medicinal product has been completely swallowed. If the patient is unable to swallow and has a nasogastric or gastrostomy tube *in situ*, Evrysdi can be administered via the tube. The tube should be flushed with water after delivering Evrysdi.

Selection of the oral syringe for the prescribed daily dose:

<i>Syringe size</i>	<i>Dosing volume</i>	<i>Syringe markings</i>
1 mL	0.3 mL to 1 mL	0.01 mL
6 mL	1 mL to 6 mL	0.1 mL
12 mL	6.2 mL to 6.6 mL	0.2 mL

For the calculation of dosing volume, the syringe markings need to be considered. The dose volume should be rounded to the nearest graduation mark on the selected oral syringe.

4.3 Contraindications

Hypersensitivity to the active substance or to any of the excipients listed in section 6.1.

4.4 Special warnings and precautions for use

Potential embryo-foetal toxicity

Embryo-foetal toxicity has been observed in animal studies (see section 5.3). Patients of reproductive potential should be informed of the risks and must use highly effective contraception during treatment and until at least 1 month after the last dose in female patients, and 4 months after the last dose in male patients. The pregnancy status of female patients of reproductive potential should be verified prior to initiating Evrysdi therapy (see section 4.6).

Potential effects on male fertility

Based on observations from animal studies, male patients should not donate sperm while on treatment and for 4 months after the last dose of Evrysdi. Prior to initiating treatment, fertility preservation strategies should be discussed with male patients of reproductive potential (see sections 4.6 and 5.3). The effects of Evrysdi on male fertility have not been investigated in humans.

Retinal toxicity

The effects of Evrysdi on retinal structure observed in the non-clinical safety studies have not been observed in clinical studies with SMA patients. However, long-term data are still limited. The clinical relevance of these nonclinical findings in the long-term has therefore not been established (see section 5.3).

Excipients

Isomalt

Evrysdi contains isomalt (2.97 mg per mL). Patients with rare hereditary problems of fructose intolerance should not take this medicine.

Sodium

Evrysdi contains 0.375 mg of sodium benzoate per mL. Sodium benzoate may increase jaundice (yellowing of the skin and eyes) in newborn babies (up to 4 weeks old).

Evrysdi contains less than 1 mmol sodium (23 mg) per 5 mg dose, i.e. is essentially 'sodium-free'.

4.5 Interaction with other medicinal products and other forms of interaction

Risdiplam is primarily metabolized by hepatic enzymes flavin monooxygenase 1 and 3 (FMO1 and 3), and also by cytochrome P450 enzymes (CYPs) 1A1, 2J2, 3A4, and 3A7. Risdiplam is not a substrate of human multidrug resistance protein 1 (MDR1).

Effects of other medicinal products on risdiplam

Co-administration of 200 mg itraconazole twice daily, a strong CYP3A inhibitor, with a single oral dose of 6 mg risdiplam did not exhibit a clinically relevant effect on the PK parameters of risdiplam (11% increase in AUC, 9% decrease in C_{max}). No dose adjustments are required when Evrysdi is co-administered with a CYP3A inhibitor.

No drug-drug interactions are expected via the FMO1 and FMO3 pathway.

Effects of risdiplam on other medicinal products

Risdiplam is a weak inhibitor of CYP3A. In healthy adult subjects, oral administration of risdiplam once daily for 2 weeks slightly increased the exposure of midazolam, a sensitive CYP3A substrate (AUC 11%; C_{max} 16%). The extent of the interaction is not considered clinically relevant, and therefore no dose adjustment is required for CYP3A substrates.

In vitro studies have shown that risdiplam and its major human metabolite M1 are not significant inhibitors of human MDR1, organic anion-transporting polypeptide (OATP)1B1, OATP1B3, organic anion transporter 1 and 3 (OAT 1 and 3). However, risdiplam and its metabolite are *in vitro* inhibitors of the human organic cation transporter 2 (OCT2) and the multidrug and toxin extrusion (MATE)1 and MATE2-K transporters. At therapeutic drug concentrations, no interaction is expected with OCT2 substrates. The effect of co-administration of risdiplam on the pharmacokinetics of MATE1 and MATE2-K substrates in humans is unknown. Based on *in vitro* data, risdiplam may increase plasma concentrations of medicinal products eliminated via MATE1 or MATE2-K, such as metformin. If co-administration cannot be avoided, drug-related toxicities should be monitored and dosage reduction of the co-administered medicinal product should be considered if needed.

There is no efficacy or safety data to support the concomitant use of risdiplam and nusinersen.

The potential for synergistic effects of concomitant administration of risdiplam with retinotoxic drugs has not been studied. Therefore, caution in using concomitant medications with known or suspected retinal toxicity is recommended.

4.6 Fertility, pregnancy and lactation

Patients of reproductive potential

Contraception in male and female patients

Male and female patients of reproductive potential should adhere to the following contraception requirements:

- Female patients of childbearing potential should use highly effective contraception during treatment and for at least 1 month after the last dose.
- Male patients, and their female partners of childbearing potential, should both ensure that highly effective contraception is achieved during treatment and for at least 4 months after the last dose.

Pregnancy testing

The pregnancy status of female patients of reproductive potential should be verified prior to initiating Evrysdi therapy. Pregnant women should be clearly advised of the potential risk to the foetus.

Pregnancy

There are no data from the use of Evrysdi in pregnant women. Studies in animals have shown reproductive toxicity (see section 5.3).

Evrysdi is not recommended during pregnancy and in women of childbearing potential not using contraception (see section 4.4).

Breast-feeding

It is not known whether risdiplam is excreted in human breast milk. Studies in rats show that risdiplam is excreted into milk (see section 5.3). As the potential for harm to the breastfed infant is unknown, it is recommended not to breastfeed during treatment.

Fertility

Male patients

Male fertility may be compromised while on treatment, based on nonclinical findings. In rat and monkey reproductive organs, sperm degeneration and reduced sperm numbers were observed (see section 5.3). Based on observations from animal studies, the effects on sperm cells are expected to be reversible upon discontinuation of risdiplam.

Male patients may consider sperm preservation prior to treatment initiation or after a treatment-free period of at least 4 months. Male patients who wish to father a child should stop treatment for a minimum of 4 months. Treatment may be re-started after conception.

Female patients

Based on nonclinical data (see section 5.3), an impact of risdiplam on female fertility is not expected.

4.7 Effects on ability to drive and use machines

Evrysdi has no or negligible influence on the ability to drive and use machines.

4.8 Undesirable effects

Summary of the safety profile

In infantile-onset SMA patients, the most common adverse reactions observed in Evrysdi clinical studies were pyrexia (54.8%), rash (29.0%) and diarrhoea (19.4%).

In later-onset SMA patients, the most common adverse reactions observed in Evrysdi clinical studies were pyrexia (21.7%), headache (20.0%), diarrhoea (16.7%), and rash (16.7%).

The adverse reactions listed above occurred without an identifiable clinical or time pattern and generally resolved despite ongoing treatment in infantile-onset and later-onset SMA patients.

Based on the primary analysis of RAINBOWFISH, the safety profile of Evrysdi in pre-symptomatic patients is consistent with the safety profile of symptomatic infantile-onset and later-onset SMA patients. The RAINBOWFISH study enrolled 26 patients with pre-symptomatic SMA between 16 and 41 days of age at the time of the first dose (weight range 3.1 to 5.7 kg). The median exposure duration was 20.4 months (range: 10.6 to 41.9 months). Limited post-marketing data are available in neonates <20 days of age.

See also section 5.3 for the effects of Evrysdi observed in nonclinical studies.

Tabulated list of adverse reactions

The corresponding frequency category for each adverse drug reaction is based on the following convention: very common ($\geq 1/10$), common ($\geq 1/100$ to $< 1/10$), uncommon ($\geq 1/1,000$ to $< 1/100$), rare ($\geq 1/10,000$ to $< 1/1,000$), very rare ($< 1/10,000$). Adverse drug reactions from clinical studies (Table 2) are listed by MedDRA system organ class.

Table 2. Adverse drug reactions occurring in patients with infantile-onset and later-onset SMA based on Evrysdi clinical studies

System Organ Class	Infantile-onset SMA (Type 1)	Later-onset SMA (Type 2 and 3)
Gastrointestinal disorders		
Diarrhoea	Very common	Very common
Nausea	Not applicable	Common
Mouth ulcerations and aphthous ulcers	Common	Common
Skin and subcutaneous tissue disorders		
Rash*	Very common	Very common
Nervous system disorders		
Headache	Not applicable	Very common
General disorders and administration site conditions		
Pyrexia (including hyperpyrexia)	Very common	Very common
Infections and infestations		
Urinary tract infection (including cystitis)	Common	Common
Musculoskeletal and connective tissue disorders		
Arthralgia	Not applicable	Common

*Includes dermatitis, dermatitis acneiform, dermatitis allergic, erythema, folliculitis, rash, rash erythematous, rash maculo-papular, rash papular

Safety profile in patients previously treated with other SMA-modifying therapies

Based on the primary analysis of the JEWELFISH study, the safety profile of Evrysdi in SMA treatment non-naïve patients who received Evrysdi for up to 59 months (including those previously treated with nusinersen [n=76] or with onasemnogene abeparvovec [n=14]) is consistent with the safety profile in SMA treatment-naïve patients treated with Evrysdi in the FIREFISH, SUNFISH and RAINBOWFISH studies (see section 5.1).

Post-marketing experience

Cutaneous vasculitis was reported during post-marketing experience. Symptoms recovered after permanent discontinuation of Evrysdi. The frequency cannot be estimated based on available data.

Reporting of suspected adverse reactions

Reporting suspected adverse reactions after authorisation of the medicinal product is important. It allows continued monitoring of the benefit/risk balance of the medicinal product. Healthcare

professionals are asked to report any suspected adverse reactions via the national reporting system listed in [Appendix V](#).

4.9 Overdose

There is no known antidote for overdosage of Evrysdi. In the event of an overdose, the patient should be closely supervised and supportive care instituted.

5. PHARMACOLOGICAL PROPERTIES

5.1 Pharmacodynamic properties

Pharmacotherapeutic group: Other drugs for disorders of the musculo-skeletal system
ATC code: M09AX10

Mechanism of action

Risdiplam is a survival of motor neuron 2 (*SMN2*) pre-mRNA splicing modifier designed to treat SMA caused by mutations of the *SMN1* gene in chromosome 5q that lead to SMN protein deficiency. Functional SMN protein deficiency is directly linked to the SMA pathophysiology which includes progressive loss of motor neurons and muscle weakness. Risdiplam corrects the splicing of *SMN2* to shift the balance from exon 7 exclusion to exon 7 inclusion into the mRNA transcript, leading to an increased production of functional and stable SMN protein. Thus, risdiplam treats SMA by increasing and sustaining functional SMN protein levels.

Pharmacodynamic effects

In the studies FIREFISH (patients aged 2-7 months at enrolment), SUNFISH (patients aged 2-25 years at enrolment), and JEWELFISH (patients aged 1-60 years at enrolment) in infantile-onset SMA and later-onset SMA patients, risdiplam led to an increase in SMN protein in blood with a greater than 2-fold median change from baseline within 4 weeks of treatment initiation across all SMA types studied. The increase was sustained throughout the treatment period (of at least 24 months).

Cardiac electrophysiology

The effect of risdiplam on the QTc interval was evaluated in a study in 47 healthy adult subjects. At the therapeutic exposure, risdiplam did not prolong the QTc interval.

Clinical efficacy and safety

The efficacy of Evrysdi for the treatment of SMA patients with infantile-onset (SMA Type 1) and later-onset SMA (SMA type 2 and 3) was evaluated in 2 pivotal clinical studies, FIREFISH and SUNFISH. Efficacy data of Evrysdi for the treatment of pre-symptomatic SMA patients was evaluated in the RAINBOWFISH clinical study. Patients with a clinical diagnosis of Type 4 SMA have not been studied in clinical trials.

Infantile-onset SMA

Study BP39056 (FIREFISH) is an open-label, 2-part study to investigate the efficacy, safety, PK and pharmacodynamics (PD) of Evrysdi in symptomatic Type 1 SMA patients (all patients had genetically confirmed disease with 2 copies of the *SMN2* gene). Part 1 of FIREFISH was designed as a dose-finding part of the study. The confirmatory Part 2 of the FIREFISH study assessed the efficacy of Evrysdi. Patients from Part 1 did not take part in Part 2.

The key efficacy endpoint was the ability to sit without support for at least 5 seconds, as measured by Item 22 of the Bayley Scales of Infant and Toddler Development – Third Edition (BSID-III) gross motor scale, after 12 months of treatment.

FIREFISH Part 2

In FIREFISH Part 2, 41 patients with Type 1 SMA were enrolled. The median age of onset of clinical signs and symptoms of Type 1 SMA was 1.5 months (range: 1.0-3.0 months), 54% were female, 54% Caucasian and 34% Asian. The median age at enrolment was 5.3 months (range: 2.2-6.9 months) and the median time between onset of symptoms and first dose was 3.4 months (range: 1.0-6.0 months). At baseline, the median Children's Hospital of Philadelphia Infant Test for Neuromuscular Disease (CHOP-INTEND) score was 22.0 points (range: 8.0-37.0) and the median Hammersmith Infant Neurological Examination Module 2 (HINE-2) score was 1.0 (range: 0.0-5.0).

The primary endpoint was the proportion of patients with the ability to sit without support for at least 5 seconds after 12 months of treatment (BSID-III gross motor scale, Item 22). The key efficacy endpoints of Evrysdi treated patients are shown in Table 3.

Table 3. Summary of key efficacy results at month 12 and month 24 (FIREFISH Part 2)

Efficacy Endpoints	Proportion of Patients N=41 (90% CI)	
	Month 12	Month 24
<u>Motor function and development milestones</u>		
BSID-III: sitting without support for at least 5 seconds	29.3% (17.8%, 43.1%) p <0.0001 ^a	61.0% (46.9%, 73.8%)
CHOP-INTEND: score of 40 or higher	56.1% (42.1%, 69.4%)	75.6% (62.2%, 86.1%)
CHOP-INTEND: increase of ≥4 points from baseline	90.2% (79.1%, 96.6%)	90.2% (79.1%, 96.6%)
HINE-2: motor milestone responders ^b	78.0% (64.8%, 88.0%)	85.4% (73.2%, 93.4%)
HINE-2: sitting without support ^c	24.4% (13.9%, 37.9%)	53.7% (39.8%, 67.1%)
<u>Survival and event-free survival</u>		
Event-free survival ^d	85.4% (73.4%, 92.2%)	82.9% (70.5%, 90.4%)
Alive	92.7% (82.2%, 97.1%)	92.7% (82.2%, 97.1%)
<u>Feeding</u>		
Ability to feed orally ^e	82.9% (70.3%, 91.7%)	85.4% (73.2%, 93.4%)

Abbreviations: CHOP-INTEND=Children’s Hospital of Philadelphia Infant Test of Neuromuscular Disorders; HINE-2=Module 2 of the Hammersmith Infant Neurological Examination.

^a p-value is based on a one-sided exact binomial test. The result is compared to a threshold of 5%.

^b According to HINE-2: ≥2 point increase [or maximal score] in ability to kick, OR ≥1 point increase in the motor milestones of head control, rolling, sitting, crawling, standing or walking, AND improvement in more categories of motor milestones than worsening is defined as a responder for this analysis.

^c Sitting without support includes patients that achieved “stable sit” (24%, 10/41) and “pivots (rotates)” (29%, 12/41) as assessed by the HINE-2 at Month 24.

^d An event is meeting the endpoint of permanent ventilation defined as tracheostomy or ≥16 hours of non-invasive ventilation per day or intubation for > 21 consecutive days in the absence of, or following the resolution of, an acute reversible event. Three patients died within the first 3 months following study enrolment and 4 patients met the endpoint of permanent ventilation before Month 24. These 4 patients achieved an increase of at least 4 points in their CHOP-INTEND score from baseline.

^e Includes patients who were fed exclusively orally (29 patients overall) and those who were fed orally in combination with a feeding tube (6 patients overall) at Month 24.

At Month 24, 44% of patients achieved sitting without support for 30 seconds (BSID-III, Item 26). Patients continued to achieve additional motor milestones as measured by the HINE-2: 80.5% were able to roll, and 27% of patients achieved a standing measure (12% supporting weight and 15% standing with support).

Untreated patients with infantile-onset SMA would never be able to sit without support and only 25% would be expected to survive without permanent ventilation beyond 14 months of age.

Figure 1. Kaplan-Meier plot of event-free survival (FIREFISH Part 1 and Part 2)

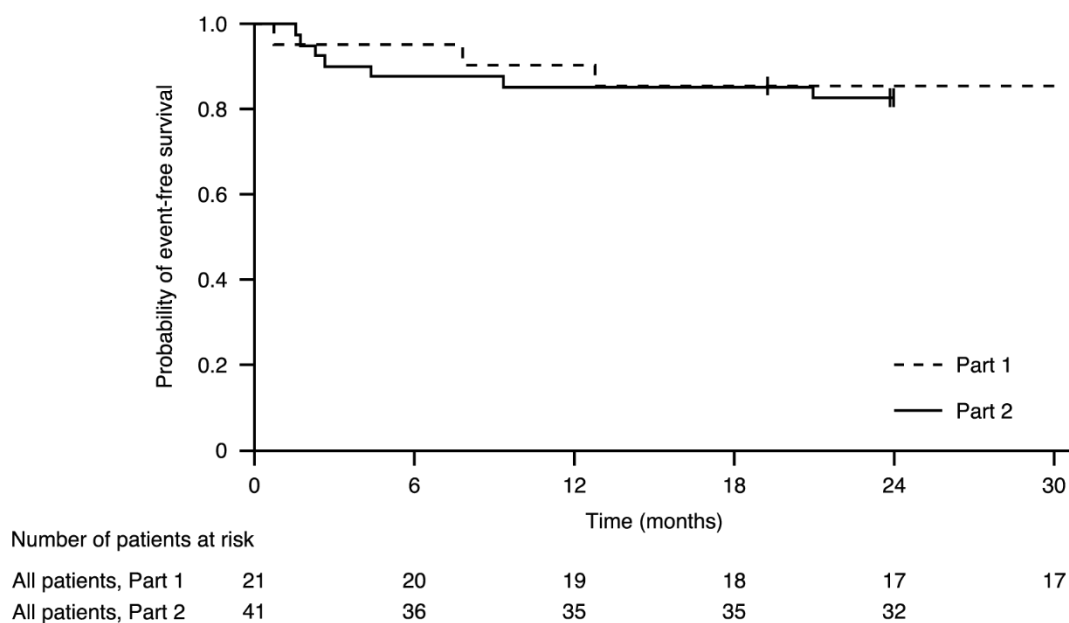

+ Censored: two patients in Part 2 were censored because the patients attended the Month 24 visit early, one patient in Part 1 was censored after discontinuing treatment and died 3.5 months later

Figure 2. Mean change from baseline in CHOP-INTEND total score (FIREFISH Part 2)

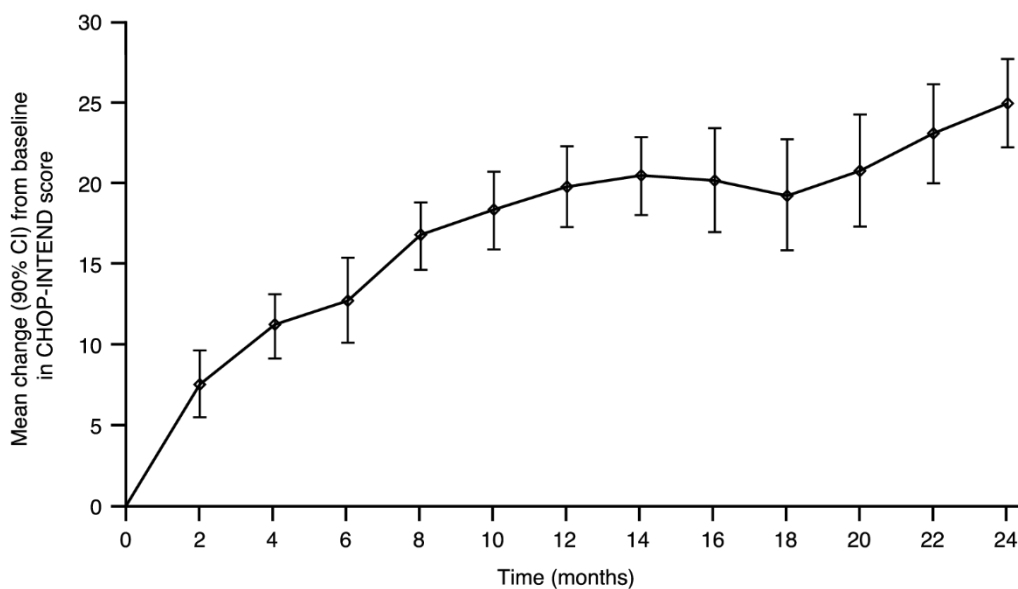

FIREFISH Part 1

The efficacy of Evrysdi in Type 1 SMA patients is also supported by results from FIREFISH Part 1. For the 21 patients from Part 1, the baseline characteristics were consistent with symptomatic patients with Type 1 SMA. The median age at enrolment was 6.7 months (range: 3.3-6.9 months) and the median time between onset of symptoms and first dose was 4.0 months (range: 2.0-5.8 months).

A total of 17 patients received the therapeutic dose of Evrysdi (dose selected for Part 2). After 12 months of treatment, 41% (7/17) of these patients were able to sit independently for at least 5 seconds (BSID-III, Item 22). After 24 months of treatment, 3 more patients receiving the therapeutic dose were able to sit independently for at least 5 seconds, leading to a total of 10 patients (59%) achieving this motor milestone.

After 12 months of treatment, 90% (19/21) of patients were alive and event-free (without permanent ventilation) and reached 15 months of age or older. After a minimum of 33 months of treatment, 81% (17/21) of patients were alive and event-free and reached an age of 37 months or older (median 41 months; range 37 to 53 months), see Figure 1. Three patients died during treatment and one patient died 3.5 months after discontinuing treatment.

Later Onset SMA

Study BP39055 (SUNFISH), is a 2-part, multicentre study to investigate the efficacy, safety, PK and PD of Evrysdi in SMA Type 2 or Type 3 patients between 2-25 years of age. Part 1 was the exploratory dose-finding portion and Part 2 was the randomized, double-blind, placebo-controlled confirmatory portion. Patients from Part 1 did not take part in Part 2.

The primary endpoint was the change from baseline score at Month 12 on the Motor Function Measure-32 (MFM32). The MFM32 has the ability to assess a wide range of motor function across a broad range of SMA patients. The total MFM32 score is expressed as a percentage (range: 0-100) of the maximum possible score, with higher scores indicating greater motor function.

SUNFISH Part 2

SUNFISH Part 2 is the randomized, double-blinded, placebo-controlled portion of the SUNFISH study in 180 non-ambulant patients with Type 2 (71%) or Type 3 (29%) SMA. Patients were randomized with 2:1 ratio to receive either Evrysdi at the therapeutic dose (see section 4.2) or placebo. Randomization was stratified by age group (2 to 5, 6 to 11, 12 to 17, 18 to 25 years old).

The median age of patients at the start of treatment was 9.0 years old (range 2-25 years old), the median time between onset of initial SMA symptoms to first treatment was 102.6 (1-275) months. Overall, 30% were 2 to 5 years of age, 32% were 6 to 11 years of age, 26% were 12-17 years of age, and 12% were 18 to 25 years of age at study enrolment. Of the 180 patients included in the study, 51% were female, 67% Caucasian and 19% Asian. At baseline, 67% of patients had scoliosis (32% of patients with severe scoliosis). Patients had a mean baseline MFM32 score of 46.1 and Revised Upper Limb Module (RULM) score of 20.1. The baseline demographic characteristics were balanced between Evrysdi and placebo arms with the exception of scoliosis (63% of patients in the Evrysdi arm and 73% of patients in the placebo control).

The primary analysis for SUNFISH Part 2, the change from baseline in MFM32 total score at Month 12, showed a clinically meaningful and statistically significant difference between patients treated with Evrysdi and placebo. The results of the primary analysis and key secondary endpoints are shown in Table 4, Figure 3, and Figure 4.

Table 4. Summary of efficacy in patients with later-onset SMA at month 12 of treatment (SUNFISH Part 2)

Endpoint	Evrysdi (N = 120)	Placebo (N = 60)
Primary Endpoint:		
Change from baseline in MFM32 total score ¹ at Month 12 LS mean (95%, CI)	1.36 (0.61, 2.11)	-0.19 (-1.22, 0.84)
Difference from placebo Estimate (95% CI) p-value ²	1.55 (0.30, 2.81) 0.0156	
Secondary Endpoints:		
Proportion of patients with a change from baseline in MFM32 total score ¹ of 3 or more at Month 12 (95% CI) ¹	38.3% (28.9, 47.6)	23.7% (12.0, 35.4)
Odds ratio for overall response (95% CI) Adjusted(unadjusted) p-value ^{3,4}	2.35 (1.01, 5.44) 0.0469 (0.0469)	
Change from baseline in RULM total score ⁵ at Month 12 LS mean (95% CI)	1.61 (1.00, 2.22)	0.02 (-0.83, 0.87)
Difference from placebo estimate (95% CI) Adjusted (unadjusted) p-value ^{2,4}	1.59 (0.55, 2.62) 0.0469 (0.0028)	

LS=least squares

1. Based on the missing data rule for MFM32, 6 patients were excluded from the analysis (Evrysdi n=115; placebo control n=59).
2. Data analysed using a mixed model repeated measure with baseline total score, treatment, visit, age group, treatment-by-visit and baseline-by-visit.
3. Data analysed using logistic regression with baseline total score, treatment and age group.
4. The adjusted p-value was obtained for the endpoints included in the hierarchical testing and was derived based on all the p-values from endpoints in order of the hierarchy up to the current endpoint
5. Based on the missing data rule for RULM, 3 patients were excluded from the analysis (Evrysdi n=119; placebo control n=58).

Upon completion of 12 months of treatment, 117 patients continued to receive Evrysdi. At the time of the 24 month analysis, these patients who were treated with Evrysdi for 24 months overall experienced maintenance of improvement in motor function between month 12 and month 24. The mean change from baseline for MFM32 was 1.83 (95% CI: 0.74, 2.92) and for RULM was 2.79 (95% CI: 1.94, 3.64).

Figure 3. Mean change from baseline in MFM32 total score over 12 months in SUNFISH Part 2¹

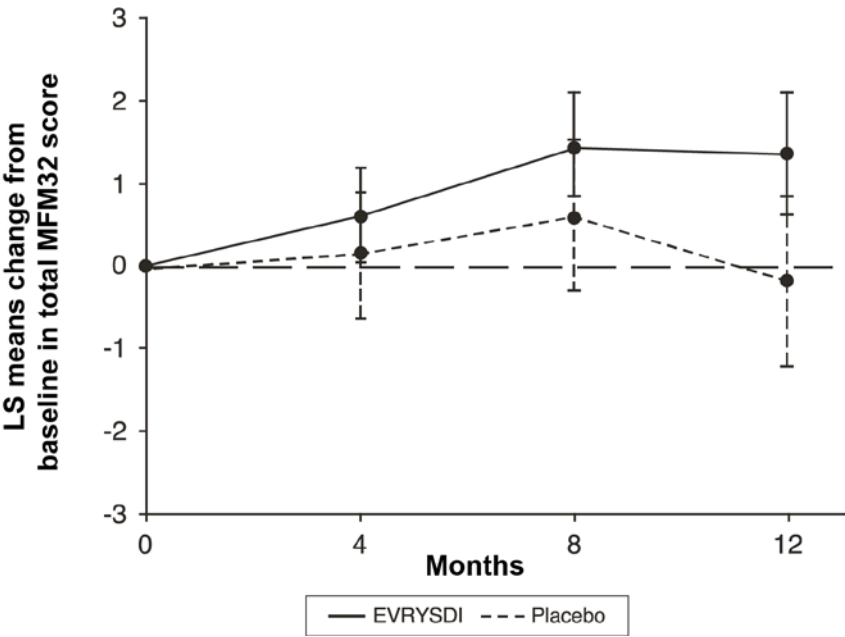

¹The least squares (LS) mean difference for change from baseline in MFM32 score [95% CI]

Figure 4. Mean change from baseline in RULM total score over 12 months in SUNFISH Part 2¹

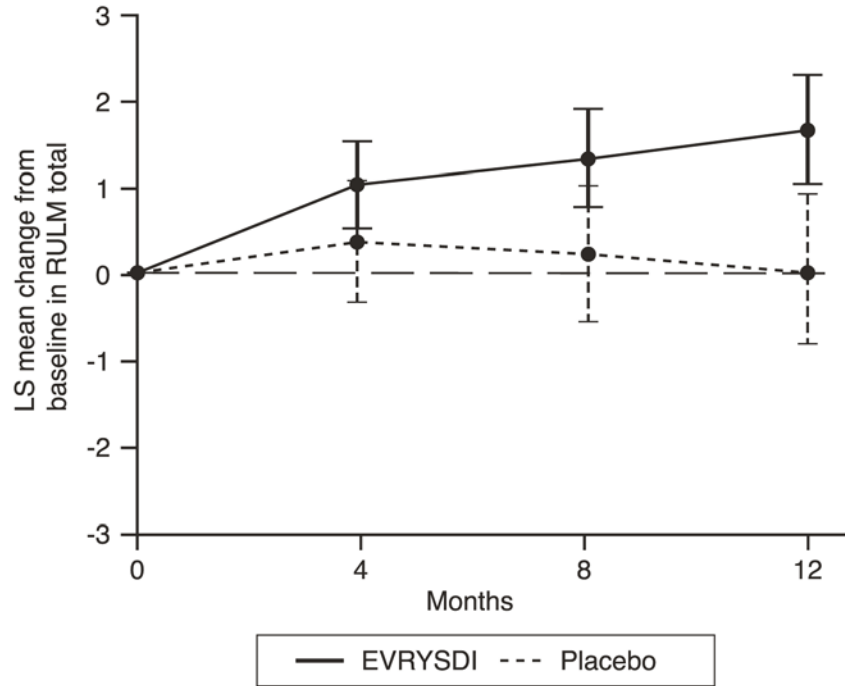

¹The least squares (LS) mean difference for change from baseline in RULM score [95% CI]

SUNFISH Part 1

Efficacy in later-onset SMA patients was also supported by results from Part 1, the dose-finding part of SUNFISH. In Part 1, 51 patients with Type 2 and 3 SMA (including 7 ambulatory patients) between 2 to 25 years of age were enrolled. After 1 year of treatment there was a clinically meaningful improvement in motor function as measured by MFM32, with a mean change from baseline of 2.7 points (95% CI: 1.5, 3.8). The improvement in MFM32 was maintained up to 2 years on treatment (mean change of 2.7 points [95% CI: 1.2, 4.2]).

Use in patients previously treated with other SMA-modifying therapies (JEWELFISH)

Study BP39054 (JEWELFISH, n = 174) is a single arm, open-label study to investigate the safety, tolerability, PK and PD of Evrysdi in patients with infantile-onset and later-onset SMA (median age 14 years [range 1 - 60 years]), who had previously received treatment with other approved (nusinersen n = 76, onasemnogene abeparvovec n = 14) or investigational SMA modifying therapies. At baseline, out of the 168 patients aged 2 - 60 years, 83% of patients had scoliosis and 63% had a Hammersmith Functional Motor Scale Expanded (HFMSE) score < 10 points.

At the analysis at month 24 of treatment, patients 2 - 60 years of age showed overall stabilization in motor function in MFM-32 and RULM (n = 137 and n = 133, respectively). Patients less than 2 years (n = 6) maintained or gained motor milestones such as head control, rolling and sitting independently. All ambulatory patients (aged 5 - 46 years, n = 15) retained their ability to walk.

Pre-symptomatic SMA (RAINBOWFISH)

Study BN40703 (RAINBOWFISH) is an open-label, single-arm, multicenter clinical study to investigate the efficacy, safety, pharmacokinetics, and pharmacodynamics of Evrysdi in infants from birth to 6 weeks of age (at first dose) who have been genetically diagnosed with SMA but do not yet present with symptoms.

The efficacy in pre-symptomatic SMA patients was evaluated at Month 12 in 26 patients [intent-to-treat (ITT) population] treated with Evrysdi: eight patients, 13 patients, and 5 patients had 2, 3, and ≥ 4 copies of the *SMN2* gene, respectively. The median age of these patients at first dose was 25 days (range: 16 to 41 days), 62% were female, and 85% were Caucasian. At baseline, the median CHOP-INTEND score was 51.5 (range: 35.0 to 62.0), the median HINE-2 score was 2.5 (range: 0 to 6.0), and the median ulnar nerve compound muscle action potential (CMAP) amplitude was 3.6 mV (range: 0.5 to 6.7 mV).

The primary efficacy population (N=5) included patients with 2 *SMN2* copies and a baseline CMAP amplitude ≥ 1.5 mV. In these patients, the median CHOP-INTEND score was 48.0 (range: 36.0 to 52.0), the median HINE-2 score was 2.0 (range 1.0 to 3.0), and the median CMAP amplitude was 2.6 mV (range: 1.6 to 3.8 mV) at baseline.

The primary endpoint was the proportion of patients in the primary efficacy population with the ability to sit without support for at least 5 seconds (BSID-III gross motor scale, Item 22) at Month 12; a statistically significant and clinically meaningful proportion of patients achieved this milestone compared to the predefined performance criterion of 5%.

The key efficacy endpoints of Evrysdi treated patients are shown in Table 5 and 6, and in Figure 5.

Table 5. Sitting ability as defined by BSID-III Item 22 for pre-symptomatic patients at Month 12

Efficacy Endpoint	Population		
	Primary Efficacy (N=5)	Patients with 2 <i>SMN2</i> copies ^a (N=8)	ITT (N=26)
Proportion of patients sitting without support for at least 5 seconds (BSID-III, Item 22); (90% CI)	80% (34.3%, 99.0%) $p < 0.0001^b$	87.5% (52.9%, 99.4%)	96.2% (83.0%, 99.8%)

Abbreviations: BSID-III = Bayley Scales of Infant and Toddler Development – Third Edition; CI=Confidence Interval; ITT=Intent-to-treat.

^a Patients with 2 *SMN2* copies had a median CMAP amplitude of 2.0 (range 0.5 – 3.8) at baseline.

^b p-value is based on a one-sided exact binomial test. The result is compared to a threshold of 5%.

Additionally, 80% (4/5) of the primary efficacy population, 87.5% (7/8) of patients with 2 *SMN2* copies, and 80.8% (21/26) of patients in the ITT population achieved sitting without support for 30 seconds (BSID-III, Item 26).

Patients in the ITT population also achieved motor milestones as measured by the HINE-2 at Month 12 (N=25). In this population 96.0% of patients could sit [1 patient (1/8 patients with 2 *SMN2* copies) achieved stable sit and 23 patients (6/8, 13/13, 4/4 of patients with 2, 3, and ≥ 4 *SMN2* copies, respectively) could pivot/rotate]. In addition, 84% of patients could stand; 32% (N=8) patients could stand with support (3/8, 3/13 and 2/4 patients with 2, 3, and ≥ 4 *SMN2* copies, respectively) and 52% (N=13) patients could stand unaided (1/8, 10/13 and 2/4 of patients with 2, 3, and ≥ 4 *SMN2* copies, respectively). Furthermore, 72% of patients could bounce, cruise or walk; 8% (N=2) patients could bounce (2/8 patients with 2 *SMN2* copies), 16% (N=4) could cruise (3/13 and 1/4 patients with 3 and ≥ 4 *SMN2* copies, respectively) and 48% (N=12) could walk independently (1/8, 9/13 and 2/4 patients with 2, 3, and ≥ 4 *SMN2* copies, respectively). Seven patients were not tested for walking at Month 12.

Table 6. Summary of key efficacy endpoints for pre-symptomatic patients at Month 12

Efficacy Endpoints	ITT population (N=26)
<u>Motor Function</u>	
Proportion of patients who achieve a Total score of 50 or higher in the CHOP-INTEND (90 CI%)	92% ^a (76.9%, 98.6%)
Proportion of patients who achieve a Total score of 60 or higher in the CHOP-INTEND (90 CI%)	80% ^a (62.5%, 91.8%)
<u>Feeding</u>	
Proportion of patients with the ability to feed orally (90 CI%)	96.2% ^b (83.0%, 99.8%)
<u>Healthcare Utilization</u>	
Proportion of patients with no hospitalisations ^c (90 CI%)	92.3% (77.7%, 98.6%)
<u>Event-Free Survival^d</u>	
Proportion of patients with Event-Free Survival (90 CI%)	100% (100%, 100%)

Abbreviations: CHOP-INTEND=Children’s Hospital of Philadelphia Infant Test of Neuromuscular Disorders; CI=Confidence Interval

^a Based on N=25

^b One patient was not assessed.

^c Hospitalisations include all hospital admissions which spanned at least two days, and which are not due to study requirements.

^d An event refers to death or permanent ventilation; permanent ventilation is defined as tracheostomy or ≥16 hours of non-invasive ventilation per day or intubation for > 21 consecutive days in the absence of, or following the resolution of, an acute reversible event.

Figure 5. Median Total CHOP-INTEND Scores by Visit and SMN2 copy number (ITT population)

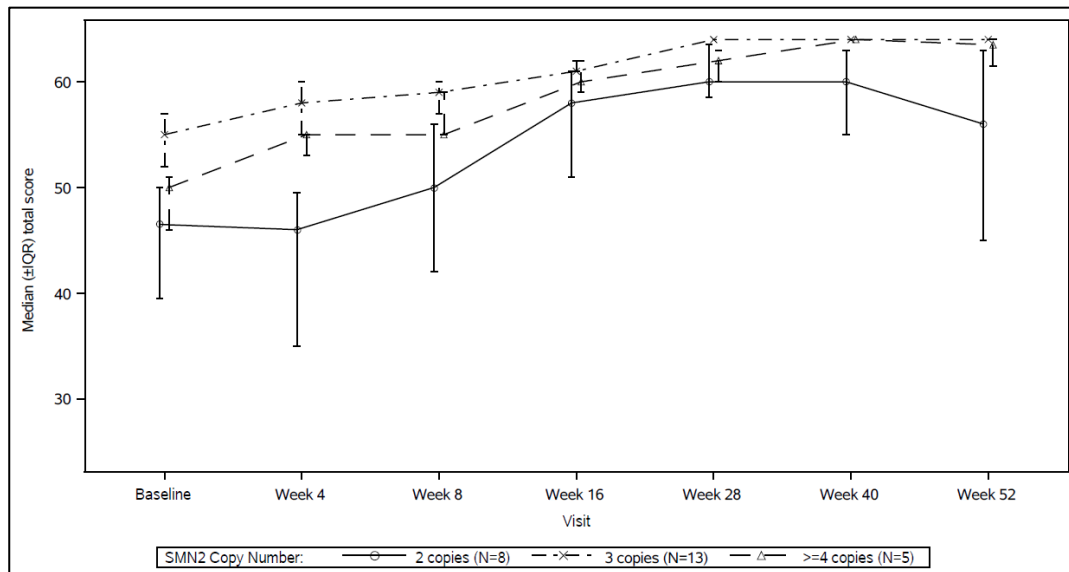

Abbreviations: IQR = Interquartile range; SMN2 = Survival of Motor Neuron 2.

5.2 Pharmacokinetic properties

Pharmacokinetic parameters have been characterised in healthy adult subjects and in patients with SMA.

After administration of treatment as an oral solution, PK of risdiplam were approximately linear between 0.6 and 18 mg. Risdiplam's PK was best described by a population PK model with three-transit-compartment absorption, two-compartment disposition and first-order elimination. Body weight and age were found to have significant effect on the PK.

The estimated exposure (mean AUC_{0-24h}) for infantile-onset SMA patients (age 2-7 months at enrolment) at the therapeutic dose of 0.2 mg/kg once daily was 1930 ng.h/mL. The estimated mean exposure in pre-symptomatic infants (16 days to <2 months of age) in the RAINBOWFISH study was 2020 ng.h/mL at 0.15 mg/kg after 2 weeks once daily administration. The estimated exposure for later-onset SMA patients (2-25 years old at enrolment) in the SUNFISH (Part 2) study at the therapeutic dose (0.25 mg/kg once daily for patients with a body weight <20 kg; 5 mg once daily for patients with a body weight \geq 20 kg) was 2070 ng.h/mL. The estimated exposure (mean AUC_{0-24h}) for SMA treatment non-naïve patients (age 1-60 years at enrolment) was 1700 ng.h/mL at the therapeutic dose of 0.25 mg/kg or 5 mg. The observed maximum concentration (mean C_{max}) was 194 ng/mL at 0.2 mg/kg in FIREFISH, 120 ng/mL in SUNFISH Part 2, 129 ng/mL in JEWELFISH, and the estimated maximum concentration at 0.15 mg/kg in RAINBOWFISH is 111 ng/mL.

Absorption

Risdiplam was rapidly absorbed in the fasted state with a plasma t_{max} ranging from 1 to 4 hours after oral administration. Based on limited data (n=3), food (high-fat, high calorie breakfast) had no relevant effect on the exposure of risdiplam. In the clinical studies, risdiplam was administered with a morning meal or after breastfeeding.

Distribution

Risdiplam distributes evenly to all parts of the body, including the central nervous system (CNS) by crossing the blood brain barrier, and thereby leading to SMN protein increase in the CNS and throughout the body. Concentrations of risdiplam in plasma and SMN protein in blood reflect its distribution and pharmacodynamic effects in tissues such as brain and muscle.

The population pharmacokinetic parameter estimates were 98 L for the apparent central volume of distribution, 93 L for the peripheral volume, and 0.68 L/hour for the inter-compartment clearance.

Risdiplam is predominantly bound to serum albumin, without any binding to alpha-1 acid glycoprotein, with a free fraction of 11%.

Biotransformation

Risdiplam is primarily metabolized by FMO1 and FMO3, and also by CYPs 1A1, 2J2, 3A4 and 3A7.

Co-administration of 200 mg itraconazole twice daily, a strong CYP3A inhibitor, with a single oral dose of 6 mg risdiplam showed no clinically relevant effect on the PK of risdiplam (11% increase in AUC, 9% decrease in C_{max}).

Elimination

Population PK analyses estimated an apparent clearance (CL/F) of 2.6 L/h for risdiplam.

The effective half-life of risdiplam was approximately 50 hours in SMA patients.

Risdiplam is not a substrate of human multidrug resistance protein 1 (MDR1).

Approximately 53% of the dose (14% unchanged risdiplam) was excreted in the feces and 28% in urine (8% unchanged risdiplam). Parent drug was the major component found in plasma, accounting for 83% of drug related material in circulation. The pharmacologically inactive metabolite M1 was identified as the major circulating metabolite.

Pharmacokinetics in special populations

Paediatric population

Body weight and age were identified as covariates in the population PK analysis. On the basis of such model, the dose is therefore adjusted based on age (below and above 2 months and 2 years) and body weight (up to 20 kg) to obtain similar exposure across the age and body weight range. Limited PK data are available in patients less than 20 days of age, since only one 16-day-old neonate received risdiplam at a lower dose (0.04 mg/kg) in clinical studies.

Elderly population

No dedicated studies have been conducted to investigate PK in patients with SMA above 60 years of age. Subjects without SMA up to 69 years of age were included in the clinical PK studies, which indicates that no dose adjustment is required for patients up to 69 years of age.

Renal impairment

No studies have been conducted to investigate the PK of risdiplam in patients with renal impairment. Elimination of risdiplam as unchanged entity via renal excretion is minor (8%).

Hepatic impairment

Mild and moderate hepatic impairment had no significant impact on the PK of risdiplam. After a single oral administration of 5 mg risdiplam, the mean ratios for C_{max} and AUC were 0.95 and 0.80 in mild (n=8) and 1.20 and 1.08 in moderate hepatic impaired subjects (n=8) versus matched healthy controls (n=10). The safety and PK in patients with severe hepatic impairment have not been studied.

Ethnicity

The PK of risdiplam do not differ in Japanese and Caucasian subjects.

5.3 Preclinical safety data

Impairment of fertility

Treatment with risdiplam was associated with male germ cell arrest in rats and monkeys without safety margins based on systemic exposures at the no observed adverse effect level (NOAEL). These effects led to degenerated spermatocytes, degeneration/necrosis of the seminiferous epithelium, and oligo/azospermia in the epididymis. Sperm cell effects of risdiplam are likely related to an interference of risdiplam with the cell cycle of dividing cells, which is stage specific and expected to be reversible. No effects were seen on female reproductive organs in rats and monkeys after treatment with risdiplam.

No fertility and early embryonic development studies were conducted with concomitant administration of risdiplam, as sperm cell arrest and embryotoxic potential under treatment was already identified with treatment of rats and monkeys in other toxicity studies. No impairment on male fertility or female fertility was observed in two studies in which rats were mated, either following completion of a 13-week treatment period starting at weaning, or 8 weeks after completion of a 4-week treatment period starting at 4 days of age.

Effect on retinal structure

Chronic treatment of monkeys with risdiplam yielded evidence for an effect on the retina in terms of photoreceptor degeneration starting in the periphery of the retina. Upon cessation of treatment, the effects on the retinogram were partially reversible but the photoreceptor degeneration did not reverse. The effects were monitored by optical coherence tomography (OCT) and by electroretinography (ERG). Effects were seen with exposures in excess of 2-fold the exposure in humans at the therapeutic dose without safety margin based on systemic exposures at the NOAEL. No such findings were observed in albino or pigmented rats when dosed chronically with risdiplam at exposures exceeding those in the monkey.

Effect on epithelial tissues

Effects on skin, larynx and eyelid histology and the gastro intestinal tract were evident in rats and monkeys treated with risdiplam. Changes started to be seen at high doses with treatment of 2 weeks and longer. With chronic treatment for 39 weeks in monkeys, the NOAEL was at an exposure in excess of 2-fold the average exposure in humans at the therapeutic dose.

Effect on haematological parameters

In the acute bone marrow micronucleus test in rats, a reduction of more than 50% in the ratio of polychromatic (young) to normochromatic (adult) erythrocytes, indicative of substantial bone marrow toxicity, was observed at the high dose level with exposure in excess of 15-times the average exposure in humans at the therapeutic dose. With longer treatment of rats for 26 weeks, the exposure margins to the NOAEL were approximately 4-fold the average exposure in humans at the therapeutic dose.

Genotoxicity

Risdiplam is not mutagenic in a bacterial reverse mutation assay. In mammalian cells in vitro and in bone marrow of rats, risdiplam increases the frequency of micronucleated cells. Micronucleus induction in bone marrow was observed in several toxicity studies in rats (adult and juvenile animals). The NOAEL across the studies is associated with an exposure of approximately 1.5-fold the exposure in humans at the therapeutic dose. Data indicated that this effect is indirect and secondary to an interference of risdiplam with the cell cycle of dividing cells. Risdiplam does not possess a potential to damage DNA directly.

Reproductive toxicity

In studies in pregnant rats treated with risdiplam, embryofoetal toxicity with lower fetal weight and delayed development was evident. The NOAEL for this effect was approximately 2-fold above the exposure levels reached at the therapeutic dose of risdiplam in patients. In studies with pregnant rabbits, dysmorphogenic effects were observed at exposures also associated with maternal toxicity. These consisted of four fetuses (4%) from 4 litters (22%) with hydrocephaly. The NOAEL was approximately 4-fold the exposure levels reached at the therapeutic dose of risdiplam in patients. In a pre- and post-natal development study in rats treated daily with risdiplam, risdiplam caused a slight delay in gestation length. Studies in pregnant and lactating rats showed that risdiplam crosses the placental barrier and is excreted into milk.

Carcinogenicity

Risdiplam did not reveal a carcinogenic potential in transgenic rasH2 mice over 6 months and in a 2 year study in rats at equivalent exposures to those in humans receiving the maximum recommended human dose (MRHD). Significantly increased tumours of the preputial gland in male rats and clitoral gland in female rats at 4 times the exposure of the MRHD are without human relevance, because both are rodent-specific organs.

Juvenile animal studies

Juvenile animal data reveal no special hazard for humans.

6. PHARMACEUTICAL PARTICULARS

6.1 List of excipients

mannitol (E 421)
isomalt (E 953)
strawberry flavour
tartaric acid (E 334)
sodium benzoate (E 211)
macrogol/polyethylene glycol 6000
sucralose
ascorbic acid (E 300)
disodium edetate dihydrate

6.2 Incompatibilities

Not applicable.

6.3 Shelf life

Powder for oral solution

2 years

Constituted oral solution

64 days stored in a refrigerator (2 to 8°C).

If necessary, the patient or their caregiver may store the oral solution at room temperature (below 40°C) for no more than a total of 120 hours (5 days). The oral solution should be returned to the refrigerator when it is no longer necessary to keep the bottle at room temperature. The total time outside the refrigerator (below 40°C) should be monitored.

The oral solution should be discarded if it has been stored at room temperature (below 40°C) for more than a total of 120 hours (5 days), or for any period of time kept above 40°C.

6.4 Special precautions for storage

Powder for oral solution

Keep in the original amber glass bottle to protect from light.

Constituted oral solution

For storage conditions after constitution of the medicinal product, see section 6.3.
Keep the oral solution in the original amber glass bottle to protect from light and keep the bottle always in an upright position with the cap tightly closed.

6.5 Nature and contents of container

Amber type III glass bottle with a tamper-evident child resistant screw cap.

Each carton contains; one bottle, 1 press-in bottle adaptor, two re-usable 1 mL, two re-usable 6 mL and one re-usable 12 mL graduated amber oral syringes.

6.6 Special precautions for disposal and other handling

Evrysdi powder must be constituted to the oral solution by a HCP (eg. pharmacist) prior to being dispensed.

Preparation

Caution should be exercised in the handling of Evrysdi powder for oral solution (see section 4.4). Avoid inhalation and direct contact with skin or mucous membranes with the dry powder and the constituted solution.

Wear disposable gloves during constitution and while wiping the outer surface of the bottle/cap and cleaning the working surface after constitution. If contact occurs, wash thoroughly with soap and water; rinse eyes with water.

Instructions for constitution:

1. Gently tap the bottom of the closed glass bottle to loosen the powder.
2. Remove the cap. Do not throw away the cap.
3. Carefully pour 79 mL of purified water or water for injection into the Evrysdi bottle to yield the 0.75 mg/mL oral solution.
4. Hold the medicine bottle on the table with one hand. Insert the press-in bottle adaptor into the opening by pushing it down with the other hand. Ensure the adaptor is completely pressed against the bottle lip.
5. Put the cap back on the bottle and close the bottle tightly. Ensure it is completely closed and then shake well for 15 seconds. Wait for 10 minutes. You should have obtained a clear solution. Afterwards, shake well again for another 15 seconds.
6. Write the “Discard after” date of the solution on the bottle label and carton. (The “Discard after” date is calculated as 64 days after constitution, the day of constitution is counted as day 0). Put the bottle back in its original carton with syringes (in pouches), Package Leaflet, and Instructions for Use booklet. Store the carton in the refrigerator (2 to 8°C).

Discard any unused portion 64 days after constitution.

Any unused medicinal product or waste material should be disposed of in accordance with local requirements.

7. MARKETING AUTHORISATION HOLDER

Roche Registration GmbH
Emil-Barell-Strasse 1
79639 Grenzach-Wyhlen,
Germany

8. MARKETING AUTHORISATION NUMBER(S)

EU/1/21/1531/001

9. DATE OF FIRST AUTHORISATION/RENEWAL OF THE AUTHORISATION

Date of first authorisation: 26 March 2021

10. DATE OF REVISION OF THE TEXT

Detailed information on this medicinal product is available on the website of the European Medicines Agency <http://www.ema.europa.eu>.

ANNEX II

- A. MANUFACTURER(S) RESPONSIBLE FOR BATCH RELEASE**
- B. CONDITIONS OR RESTRICTIONS REGARDING SUPPLY AND USE**
- C. OTHER CONDITIONS AND REQUIREMENTS OF THE MARKETING AUTHORISATION**
- D. CONDITIONS OR RESTRICTIONS WITH REGARD TO THE SAFE AND EFFECTIVE USE OF THE MEDICINAL PRODUCT**

A. MANUFACTURER(S) RESPONSIBLE FOR BATCH RELEASE

Name and address of the manufacturer(s) responsible for batch release

Roche Pharma AG
Emil-Barell-Strasse 1
79639 Grenzach-Wyhlen,
Germany

B. CONDITIONS OR RESTRICTIONS REGARDING SUPPLY AND USE

Medicinal product subject to restricted medical prescription (see Annex I: Summary of Product Characteristics, section 4.2).

C. OTHER CONDITIONS AND REQUIREMENTS OF THE MARKETING AUTHORISATION

- **Periodic safety update reports (PSURs)**

The requirements for submission of PSURs for this medicinal product are set out in the list of Union reference dates (EURD list) provided for under Article 107c(7) of Directive 2001/83/EC and any subsequent updates published on the European medicines web-portal.

The marketing authorisation holder (MAH) shall submit the first PSUR for this product within 6 months following authorisation.

D. CONDITIONS OR RESTRICTIONS WITH REGARD TO THE SAFE AND EFFECTIVE USE OF THE MEDICINAL PRODUCT

- **Risk management plan (RMP)**

The marketing authorisation holder (MAH) shall perform the required pharmacovigilance activities and interventions detailed in the agreed RMP presented in Module 1.8.2 of the marketing authorisation and any agreed subsequent updates of the RMP.

An updated RMP should be submitted:

- At the request of the European Medicines Agency;
- Whenever the risk management system is modified, especially as the result of new information being received that may lead to a significant change to the benefit/risk profile or as the result of an important (pharmacovigilance or risk minimisation) milestone being reached.
- **Obligation to conduct post-authorisation measures**

The MAH shall complete, within the stated timeframe, the below measure:

Description	Due date
Post-authorisation Efficacy Study (PAES): a long-term prospective, observational study to further evaluate disease progression in SMA patients (both pre-symptomatic and symptomatic) with 1 to 4 <i>SMN2</i> copies treated with risdiplam, in comparison to natural history data in untreated patients.	2030

ANNEX III
LABELLING AND PACKAGE LEAFLET

A. LABELLING

PARTICULARS TO APPEAR ON THE OUTER PACKAGING

OUTER CARTON

1. NAME OF THE MEDICINAL PRODUCT

Evrysdi 0.75 mg/mL powder for oral solution
risdiplam

2. STATEMENT OF ACTIVE SUBSTANCE(S)

1 bottle contains 60 mg of risdiplam in 2.0 g powder.

3. LIST OF EXCIPIENTS

Contains also sodium benzoate (E 211) and isomalt (E 953).
See leaflet for further information.

4. PHARMACEUTICAL FORM AND CONTENTS

Powder for oral solution
1 bottle
Also contains 1 press-in bottle adaptor, 5 re-usable syringes (two 1 mL, two 6 mL and one 12 mL).

5. METHOD AND ROUTE(S) OF ADMINISTRATION

Read the package leaflet before use
For oral use after constitution

6. SPECIAL WARNING THAT THE MEDICINAL PRODUCT MUST BE STORED OUT OF THE SIGHT AND REACH OF CHILDREN

Keep out of the sight and reach of children

7. OTHER SPECIAL WARNING(S), IF NECESSARY

Do not breathe the powder. Avoid skin contact with powder and constituted solution

8. EXPIRY DATE

Powder EXP

Oral solution. Discard after (dd-mm-yyyy)

9. SPECIAL STORAGE CONDITIONS

Constituted oral solution: Store in a refrigerator (2°C - 8°C). Store in original bottle, tightly closed, and always in an upright position

10. SPECIAL PRECAUTIONS FOR DISPOSAL OF UNUSED MEDICINAL PRODUCTS OR WASTE MATERIALS DERIVED FROM SUCH MEDICINAL PRODUCTS, IF APPROPRIATE**11. NAME AND ADDRESS OF THE MARKETING AUTHORISATION HOLDER**

Roche Registration GmbH
Emil-Barell-Strasse 1
79639 Grenzach-Wyhlen
Germany

12. MARKETING AUTHORISATION NUMBER(S)

EU/1/21/1531/001

13. BATCH NUMBER

Batch

14. GENERAL CLASSIFICATION FOR SUPPLY**15. INSTRUCTIONS ON USE****16. INFORMATION IN BRAILLE**

Evrysdi

17. UNIQUE IDENTIFIER – 2D BARCODE

2D barcode carrying the unique identifier included.

18. UNIQUE IDENTIFIER - HUMAN READABLE DATA

PC
SN
NN

PARTICULARS TO APPEAR ON THE IMMEDIATE PACKAGING

BOTTLE LABEL

1. NAME OF THE MEDICINAL PRODUCT

Evrysdi 0.75 mg/mL powder for oral solution
risdiplam

2. STATEMENT OF ACTIVE SUBSTANCE(S)

1 bottle contains 60 mg of risdiplam in 2.0 g powder.

3. LIST OF EXCIPIENTS

Contains also sodium benzoate (E 211) and isomalt (E 953).
See leaflet for further information.

4. PHARMACEUTICAL FORM AND CONTENTS

Powder for oral solution

5. METHOD AND ROUTE(S) OF ADMINISTRATION

Read the package leaflet before use.
For oral use.

6. SPECIAL WARNING THAT THE MEDICINAL PRODUCT MUST BE STORED OUT OF THE SIGHT AND REACH OF CHILDREN

Keep out of the sight and reach of children.

7. OTHER SPECIAL WARNING(S), IF NECESSARY

Avoid skin contact.

8. EXPIRY DATE

Powder: EXP

Oral solution. Discard after

9. SPECIAL STORAGE CONDITIONS

Oral solution: Store at 2°C - 8°C. Keep the bottle tightly closed and in an upright position.

10. SPECIAL PRECAUTIONS FOR DISPOSAL OF UNUSED MEDICINAL PRODUCTS OR WASTE MATERIALS DERIVED FROM SUCH MEDICINAL PRODUCTS, IF APPROPRIATE

11. NAME AND ADDRESS OF THE MARKETING AUTHORISATION HOLDER

Roche Registration GmbH
Emil-Barell-Strasse 1
79639 Grenzach-Wyhlen
Germany

12. MARKETING AUTHORISATION NUMBER(S)

EU/1/21/1531/001

13. BATCH NUMBER

Batch

14. GENERAL CLASSIFICATION FOR SUPPLY

15. INSTRUCTIONS ON USE

16. INFORMATION IN BRAILLE

17. UNIQUE IDENTIFIER – 2D BARCODE

18. UNIQUE IDENTIFIER - HUMAN READABLE DATA

B. PACKAGE LEAFLET

Package leaflet: Information for the patient

Evrysdi 0.75 mg/mL powder for oral solution risdiplam

▼ This medicine is subject to additional monitoring. This will allow quick identification of new safety information. You can help by reporting any side effects you may get. See the end of section 4 for how to report side effects.

Read all of this leaflet carefully before you or your child start taking this medicine because it contains important information for you.

- Keep this leaflet. You may need to read it again.
- If you have any further questions, ask your doctor or pharmacist.
- This medicine has been prescribed for you or your child only. Do not pass it on to others. It may harm them, even if their signs of illness are the same as yours.
- If you or your child get any side effects, talk to your doctor or pharmacist. This includes any possible side effects not listed in this leaflet. See section 4.

What is in this leaflet

1. What Evrysdi is and what it is used for
2. What you need to know before you or your child take Evrysdi
3. How to take Evrysdi
4. Possible side effects
5. How to store Evrysdi
6. Contents of the pack and other information

1. What Evrysdi is and what it is used for

What Evrysdi is

Evrysdi is a medicine that contains the active substance risdiplam.

What is Evrysdi used for

Evrysdi is used to treat spinal muscular atrophy (SMA), a genetic disease.

What spinal muscular atrophy is

SMA is caused by a shortage of a protein called survival motor neuron (SMN) protein in the body. Lack of SMN protein can cause you or your child to lose motor neurons, which are nerve cells that control muscles. This leads to muscle weakness and wasting that can affect everyday movements such as head and neck control, sitting, crawling and walking. The muscles used for breathing and swallowing may also become weaker.

How Evrysdi works

Risdiplam, the active substance in Evrysdi, works by helping the body produce more SMN protein. This means fewer motor neurons are lost, which may improve how well muscles work in people with SMA.

In infants with SMA Type 1 treated in clinical trials for 1 year, Evrysdi has helped to:

- increase how long they live and reduce the need for a ventilator to help with breathing compared to untreated infants with SMA (only 25% of untreated infants would be expected to be alive without the need for permanent ventilation beyond 14 months of age compared to 85% of patients after 1 year of treatment with Evrysdi),
- keep the ability to be fed by mouth in 83% of patients.

In children (toddlers to adolescents) and adults with SMA Type 2 and 3, Evrysdi may maintain or improve muscle control.

2. What you need to know before you or your child take Evrysdi

Do not take Evrysdi:

- if you or your child are allergic to risdiplam or any of the other ingredients of this medicine (listed in section 6).

If you are not sure, talk to your doctor or pharmacist before you or your child take Evrysdi.

Warnings and precautions

Talk to your doctor, nurse or pharmacist before you or your child take Evrysdi.

Treatment with Evrysdi may harm your unborn baby or may affect male fertility. See “**Pregnancy, contraception, breast-feeding and male fertility**” for more information.

Other medicines and Evrysdi

Tell your doctor or pharmacist if you or your child are taking, have recently taken or might take any other medicines in the future.

In particular tell your doctor, pharmacist or nurse if you are taking or have received in the past any of the following medicines:

- metformin – a medicine used to treat type II diabetes
- medicines for the treatment of SMA

Pregnancy, contraception, breast-feeding and male fertility

Pregnancy

- Do not take Evrysdi if you are pregnant. This is because taking this medicine while you are pregnant could harm your unborn baby.
- Before you start treatment with Evrysdi, your doctor should do a pregnancy test. This is because Evrysdi may harm your unborn baby.
- If you do become pregnant during your treatment with Evrysdi, tell your doctor straight away.

You and your doctor will decide what is best for you and your unborn baby.

Contraception

For women

Do not become pregnant:

- during your treatment with Evrysdi and
- for one month after you stop taking Evrysdi.

Talk to your doctor about reliable methods of birth control that should be used during treatment and for one month after you stop treatment.

For men

If your female partner is of childbearing potential, you need to avoid pregnancy. Use reliable methods of birth control (eg. condoms):

- during your treatment with Evrysdi and
- for 4 months after you stop taking Evrysdi.

Talk to your healthcare provider about reliable methods of birth control that should be used.

Breast-feeding

Do not breast-feed while taking this medicine. This is because Evrysdi may pass into breast milk and may, therefore, harm your baby.

Discuss with your doctor if you should stop breast-feeding or if you should stop taking Evrysdi.

Male fertility

Based on findings in animals, Evrysdi may reduce male fertility while on treatment and for up to 4 months after your last dose. If you are planning to have a child, ask your doctor for advice. Do not donate sperm during your treatment and for 4 months after your last dose of Evrysdi.

Driving and using machines

Evrysdi is unlikely to affect your ability to drive and use machines.

Evrysdi contains sodium

Evrysdi contains a small amount of sodium (salt) - there is less than 1 mmol (23 mg) sodium even at the highest daily dose of 5 mg (6.6 mL of 0.75 mg/mL oral solution). This means it is essentially 'sodium-free' and can be used by people on a sodium-restricted diet.

Evrysdi contains 0.375 mg of sodium benzoate per mL. Sodium benzoate may increase jaundice (yellowing of the skin and eyes) in newborn babies (up to 4 weeks old).

Evrysdi contains isomalt

Evrysdi contains 2.97 mg of isomalt per mL. If you have been told by your doctor that you or your child have an intolerance to some sugars, contact your doctor before taking this medicinal product.

3. How to take Evrysdi

Always take this medicine exactly as your doctor or pharmacist has told you. Check with your doctor or pharmacist if you are not sure. You should receive Evrysdi as a liquid in a bottle. Do not use if the medicine in the bottle is a powder, and contact your pharmacist.

You must also carefully read and follow the enclosed “**Instructions for use**” booklet on how to take or give Evrysdi.

How much Evrysdi to take

- **Adolescents and adults:** The daily dose of Evrysdi is 5 mg (6.6 mL of the oral solution).
- **Infants and children:** Your doctor will choose the right dose of Evrysdi based on your child’s age and weight.

You or your child must take your daily dose as instructed by your doctor. Do not change the dose without speaking with your doctor.

When and how to take Evrysdi

- Evrysdi is a liquid which is prepared by the pharmacist, and is referred to as a ‘solution’ or ‘medicine’ in this leaflet.
- Take Evrysdi once daily after a meal at around the same time each day. This will help you remember when to take your medicine.
- Drink water after taking the medicine. Do not mix the medicine with milk or formula milk.
- Take or give Evrysdi immediately after it is drawn up into the oral syringe. If it is not taken within 5 minutes, discard the medicine from the oral syringe, and withdraw a new dose
- If Evrysdi gets on you or your child’s skin, wash the area with soap and water.

Read the ‘Instructions for use’ booklet

A booklet with ‘**Instructions for use**’ is included in the pack. It shows you how to withdraw your dose using the re-usable oral syringe given to you. You (or your child) can take the medicine:

- by mouth, or
- through a gastrostomy tube, or
- through a nasogastric tube.

How long to take Evrysdi for

Your doctor will tell you how long you or your child need to take Evrysdi for. Do not stop treatment with Evrysdi unless your doctor tells you to.

If you or your child take more Evrysdi than you should

If you or your child take more Evrysdi than you should, talk to a doctor or go to hospital straight away. Take the medicine pack and this leaflet with you.

If you or your child forget to take Evrysdi or vomits after a dose

- If it is within 6 hours of when you or your child normally take Evrysdi, take the missed dose as soon as you remember.
- If it is over 6 hours from when you or your child normally take Evrysdi, skip the missed dose and then take your next dose at the usual time. Do not take a double dose to make up for a forgotten dose.

- If you or your child vomits after taking a dose of Evrysdi, do not take an extra dose. Instead, take the next dose at the usual time the next day.

If you spill Evrysdi

If you spill Evrysdi, dry the area with a dry paper towel and then clean the area with soap and water. Throw away the paper towel in the waste and wash your hands well with soap and water.

4. Possible side effects

Like all medicines, this medicine can cause side effects, although not everybody gets them.

Very common: may affect more than 1 in 10 people

- diarrhoea
- rash
- headache
- fever

Common: may affect up to 1 in 10 people

- nausea
- mouth sores
- bladder infection
- joint pain

The following side effect has been reported since the marketing of Evrysdi but the frequency for it to occur is not known:

- inflammation of small blood vessels mainly affecting the skin (cutaneous vasculitis).

Reporting of side effects

If you or your child get any side effects, talk to your doctor or pharmacist or nurse. This includes any possible side effects not listed in this leaflet. You can also report side effects directly via the national reporting system listed in [Appendix V](#). By reporting side effects you can help provide more information on the safety of this medicine.

5. How to store Evrysdi

- Keep this medicine out of the sight and reach of children.
- Store the oral solution in a refrigerator (2 to 8°C). If necessary, you or your caregiver may store the oral solution at room temperature (below 40°C) for no more than a total of 120 hours (5 days). Return the oral solution to the refrigerator when it is no longer necessary to keep the bottle at room temperature.
- Monitor the total time outside the refrigerator (below 40°C). As mentioned above, the sum of time intervals outside the refrigerator must not exceed 120 hours.
- The oral solution is stable for 64 days after the pharmacist prepares it when stored in the refrigerator at 2°C to 8°C. The pharmacist will write the date of expiration on the bottle label and on the original carton after “Discard after”. Do not use the solution past this “Discard after” date or discard the medicine if the bottle has been stored at room temperature (below 40°C) for more than a total of 120 hours (5 days).
- Discard the medicine if the bottle has been stored for any period of time at above 40°C.
- Keep the medicine in the original bottle to protect from light.
- Keep the medicine bottle upright, with the cap tightly closed.

- Once you have drawn up the medicine into the oral syringe, use Evrysdi straight away. Do not store the Evrysdi solution in the syringe.

Do not throw away any medicines via wastewater or household waste. Ask your pharmacist how to throw away medicines you no longer use. These measures will help protect the environment.

6. Contents of the pack and other information

What Evrysdi contains

- The active substance in the oral solution is risdiplam.
- Each mL of the oral solution contains 0.75 mg risdiplam.
- The other ingredients are mannitol (E 421), isomalt (E 953), strawberry flavour, tartaric acid (E 334), sodium benzoate (E 211), macrogol/polyethylene glycol 6000, sucralose, ascorbic acid (E 300), disodium edetate dihydrate (see Section 2 ‘Evrysdi contains sodium’ and ‘Evrysdi contains isomalt’).

What Evrysdi looks like and contents of the pack

- Powder for oral solution, which is delivered as an oral solution after preparation by the pharmacist.
- The solution is a greenish yellow to yellow, strawberry flavoured oral solution, the volume of the solution is 80 mL.
- Each carton contains 1 bottle, 1 press-in bottle adaptor, two 1-mL, two 6-mL and one 12-mL re-usable amber oral syringes with markings to help you withdraw the right dose.

Marketing Authorisation Holder

Roche Registration GmbH
Emil-Barell-Strasse 1
79639 Grenzach-Wyhlen
Germany

Manufacturer

Roche Pharma AG
Emil-Barell-Strasse 1
79639 Grenzach-Wyhlen
Germany

For any information about this medicine, please contact the local representative of the Marketing Authorisation Holder:

België/Belgique/Belgien

N.V. Roche S.A.
Tél/Tel: +32 (0) 2 525 82 11

Lietuva

UAB “Roche Lietuva”
Tel: +370 5 2546799

България

Рош България ЕООД
Тел: +359 2 474 5444

Luxembourg/Luxemburg

(Voir/siehe Belgique/Belgien)

Česká republika

Roche s. r. o.
Tel: +420 - 2 20382111

Magyarország

Roche (Magyarország) Kft.
Tel: +36 1 279 4500

Danmark

Roche Pharmaceuticals A/S
Tlf: +45 - 36 39 99 99

Deutschland

Roche Pharma AG
Tel: +49 (0) 7624 140

Eesti

Roche Eesti OÜ
Tel: + 372 - 6 177 380

Ελλάδα

Roche (Hellas) A.E.
Τηλ: +30 210 61 66 100

España

Roche Farma S.A.
Tel: +34 - 91 324 81 00

France

Roche
Tél: +33 (0) 1 47 61 40 00

Hrvatska

Roche d.o.o.
Tel: +385 1 4722 333

Ireland

Roche Products (Ireland) Ltd.
Tel: +353 (0) 1 469 0700

Ísland

Roche Pharmaceuticals A/S
c/o Icepharma hf
Sími: +354 540 8000

Italia

Roche S.p.A.
Tel: +39 - 039 2471

Κύπρος

Γ.Α.Σταμάτης & Σια Λτδ.
Τηλ: +357 - 22 76 62 76

Latvija

Roche Latvija SIA
Tel: +371 - 6 7039831

Malta

(see Ireland)

Nederland

Roche Nederland B.V.
Tel: +31 (0) 348 438050

Norge

Roche Norge AS
Tlf: +47 - 22 78 90 00

Österreich

Roche Austria GmbH
Tel: +43 (0) 1 27739

Polska

Roche Polska Sp.z o.o.
Tel: +48 - 22 345 18 88

Portugal

Roche Farmacêutica Química, Lda
Tel: +351 - 21 425 70 00

România

Roche România S.R.L.
Tel: +40 21 206 47 01

Slovenija

Roche farmacevtska družba d.o.o.
Tel: +386 - 1 360 26 00

Slovenská republika

Roche Slovensko, s.r.o.
Tel: +421 - 2 52638201

Suomi/Finland

Roche Oy
Puh/Tel: +358 (0) 10 554 500

Sverige

Roche AB
Tel: +46 (0) 8 726 1200

United Kingdom (Northern Ireland)

Roche Products (Ireland) Ltd.
Tel: +44 (0) 1707 366000

This leaflet was last revised in

Other sources of information

Detailed information on this medicine is available on the European Medicines Agency web site:
<http://www.ema.europa.eu>.

Instructions for Use – Administration

Evrysdi 0.75 mg/mL powder for oral solution

risdiplam

Be sure to read and understand the **Instructions for Use** before you start using Evrysdi. These instructions show you how to prepare and give Evrysdi through an oral syringe, gastrostomy tube (G- tube), or nasogastric tube (NG-tube).

If you have any questions about how to use Evrysdi, speak with your doctor or pharmacist.

Evrysdi should come as a liquid in a bottle when you receive it. Evrysdi is prepared by a pharmacist into an oral solution. **Do not** use if the medicine in the bottle is a powder and contact your pharmacist.

Important information about Evrysdi

- Ask your doctor or pharmacist to show you which oral syringe you should use and how to measure your daily dose.
- Always use the re-usable oral syringes in the pack to measure your daily dose.
- Contact your doctor or pharmacist if your oral syringe(s) is/are lost or damaged. They will advise you about how to continue to take your medicine.
- See “**How to select the correct oral syringe for your dose of Evrysdi**”. Ask your pharmacist if you have questions on how to select the right oral syringe.
- If the bottle adaptor is not in the bottle, **do not** use Evrysdi and contact your pharmacist.
- The oral solution may be stored at room temperature (below 40°C) for no more than a total of 120 hours (5 days). Monitor the total time outside the refrigerator (below 40°C).
- **Do not** use Evrysdi after the **Discard after** date written on the bottle label or if you or your caregiver have stored the bottle at room temperature (below 40°C) for more than a total of 120 hours (5 days). Ask your pharmacist for the **Discard after** date if it is not written on the bottle label.
- Discard the medicine if the bottle has been stored for any period of time at above 40°C.
- **Do not** mix Evrysdi with milk or formula milk.
- **Do not** use Evrysdi if the bottle or oral syringes are damaged.
- **Avoid** getting Evrysdi on your skin. If Evrysdi gets on your skin, wash the area with soap and water.
- If you spill Evrysdi, dry the area with a dry paper towel and then clean the area with soap and water. Throw away the paper towel in the waste and wash your hands well with soap and water.
- If there is not enough Evrysdi left in the bottle for your dose, discard the bottle with remaining Evrysdi and used oral syringes according to your local requirements; use a new bottle of Evrysdi for your full dose. **Do not mix** Evrysdi from the new bottle with the bottle you are currently using.

Each EVRYSDI carton contains (See figure A):

1. 1 Evrysdi bottle with bottle adaptor and cap
2. 1 Oral Syringe 12 mL (in pouch)
3. 2 Oral syringes 6 mL (in pouches)
4. 2 Oral syringes 1 mL (in pouches)
5. 1 Instructions for Use booklet (not shown)
6. 1 Package Leaflet (not shown)

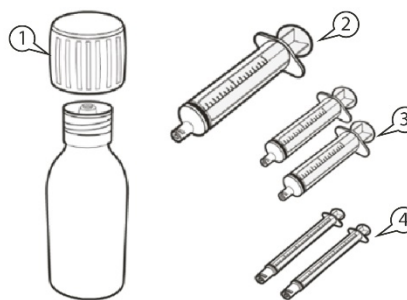

Figure A

How to store Evrysdi

Please see section 5 “*How to store Evrysdi*” of the Package Leaflet for full information.

A) Withdrawing your dose volume

How to select the correct oral syringe for your dose of Evrysdi

- If your daily dose of Evrysdi is between 0.3 mL and 1 mL, use a 1 mL oral syringe (yellow label).

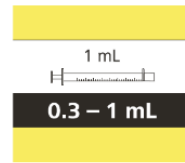

- If your daily dose of Evrysdi is between 1 mL and 6 mL, use a 6-mL oral syringe (grey label).

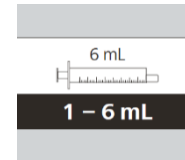

- If your daily dose of Evrysdi is more than 6 mL, use a 12-mL oral syringe (brown label).

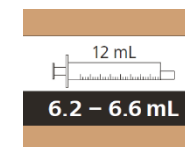

Ask your doctor or pharmacist about rounding your or your child's daily dose to the nearest syringe marking.

How to withdraw your dose of Evryydi



Figure B

Step A1

Remove the cap by pushing it down and then twisting it to the left (counter-clockwise) (See Figure B). Do not throw away the cap.

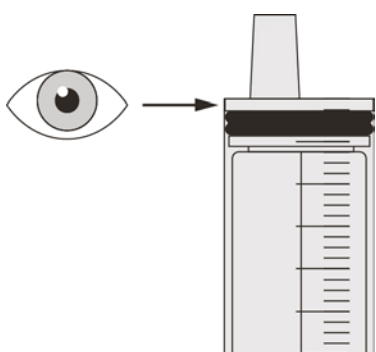

Figure C

Step A2

Push the plunger of the oral syringe all the way down to remove any air in the oral syringe (See Figure C).

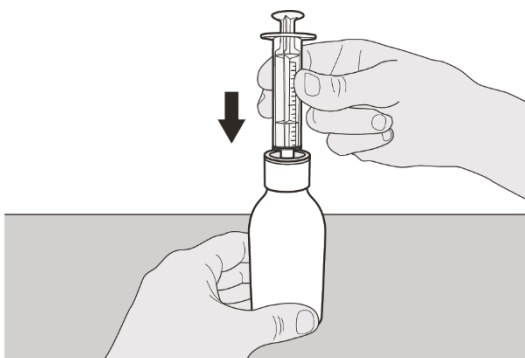

Figure D

Step A3

Keeping the bottle upright, insert the syringe tip into the bottle adaptor (See Figure D).

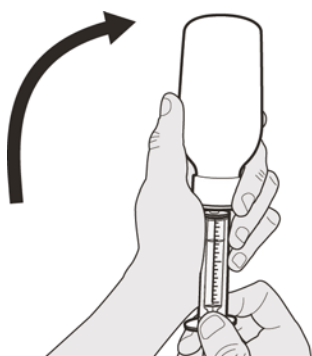

Figure E

Step A4

Carefully turn the bottle upside down with the syringe tip firmly inserted into the bottle adaptor (See Figure E).

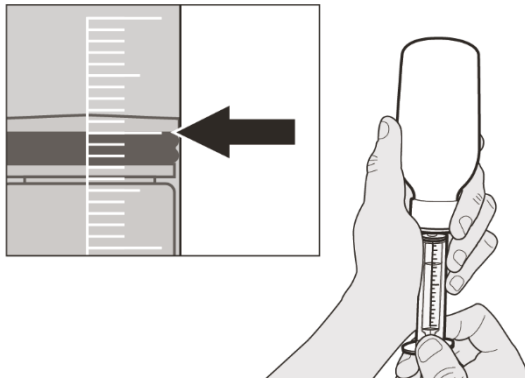

Figure F

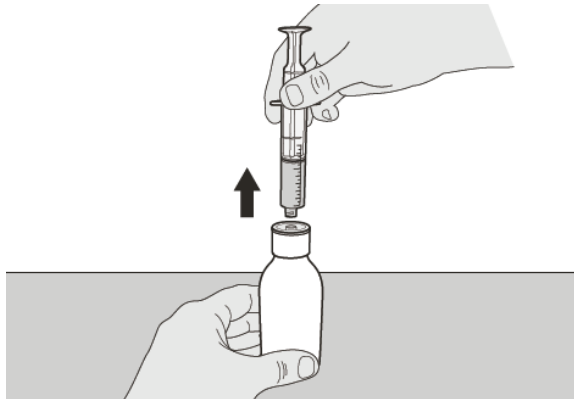

Figure G

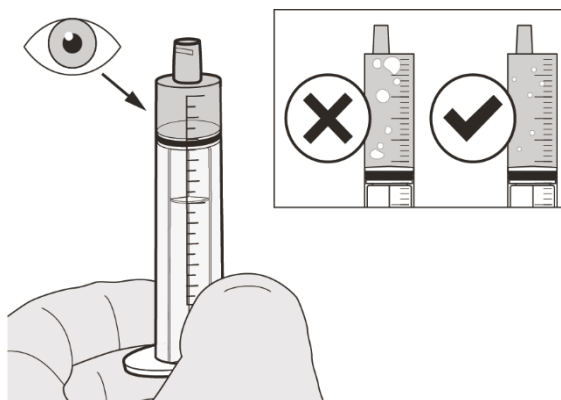

Figure H

Step A5

Slowly pull back on the plunger to withdraw your dose of Evrysdi. The top of the black plunger stopper must line up with the mL marking on the oral syringe for your daily dose (See Figure F).

After you have drawn up the correct dose, **hold the plunger in place to keep it from moving.**

Step A6

Continue to hold the plunger in place to stop it moving. Leave the oral syringe in the bottle adaptor and turn the bottle to an upright position. Place the bottle onto a flat surface. Remove the oral syringe from the bottle adaptor by gently pulling straight up on the oral syringe (See Figure G).

Step A7

Hold the oral syringe with the syringe tip pointing up. Check the medicine in the oral syringe. **If** there are large air bubbles in the oral syringe (See Figure H) **or if** you have drawn up the wrong dose of Evrysdi, insert the syringe tip firmly into the bottle adaptor. Push the plunger all the way down so that the medicine flows back into the bottle and repeat Steps A4 to A7.

Take or give Evrysdi immediately after it is drawn up into the oral syringe.

If it is not taken **within 5 minutes**, discard the medicine from oral syringe and withdraw a new dose.

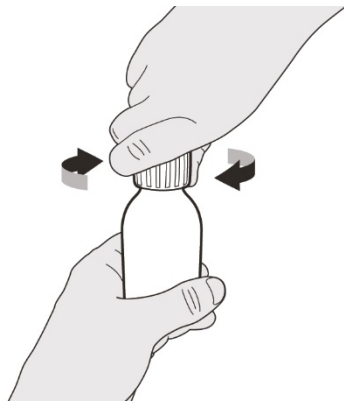

Figure I

Step A8

Put the cap back on the bottle. Turn the cap to the right (clockwise) to tightly close the bottle (See Figure I). Do not remove the bottle adaptor from the bottle.

If you are taking your dose of Evrysdi by mouth, follow the instructions in **“B) How to take a dose of Evrysdi by mouth”**.

If you are taking your dose of Evrysdi through a gastrostomy tube, follow the instructions in **“C) How to give a dose of Evrysdi through a gastrostomy tube (G-tube)”**.

If you are taking your dose of Evrysdi through a nasogastric tube, follow the instructions in **“D) How to give a dose of Evrysdi through a nasogastric tube (NG-tube)”**.

Evrysdi’s oral syringes are specifically designed to be compatible with the ENFit® system. If your feeding tube is not ENFit® compatible, you may need an ENFit® transition connector to connect the Evrysdi syringe to your G-tube or NG-tube.

B) How to take a dose of Evrysdi by mouth

Sit upright when taking a dose volume of Evrysdi by mouth.



Figure J

Step B1

Place the oral syringe into the mouth **with the tip along either cheek.**

Slowly push the plunger all the way down to give the full dose of Evrysdi (See Figure J).

Giving Evrysdi into the back of the throat or too fast may cause choking.

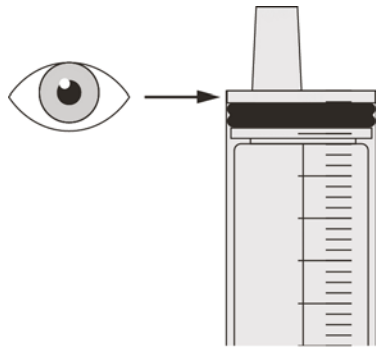

Figure K

Step B2

Check that there is no medicine left in the oral syringe (See Figure K).



Figure L

Step B3

Drink some water right after taking the dose of Evrysdi (See Figure L).

Go to Step E for cleaning of the syringe.

C) How to give a dose of Evrysdi through a gastrostomy tube

If you are giving Evrysdi through a gastrostomy tube, ask your doctor or nurse to show you how to inspect the gastrostomy tube before giving Evrysdi.

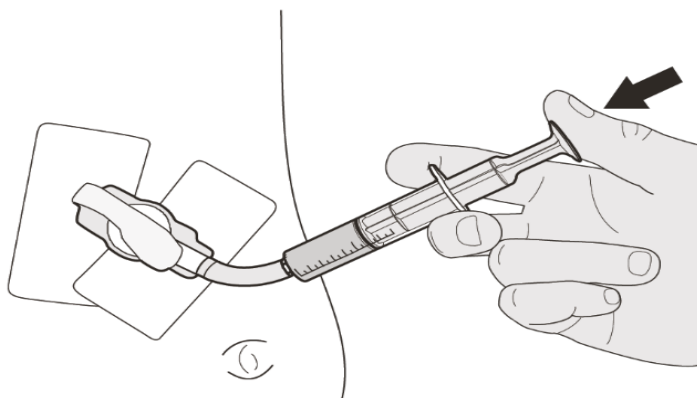

Figure M

Step C1

Place the oral syringe tip into the gastrostomy tube. Slowly push the plunger all the way down to give the full dose of Evrysdi (See Figure M).

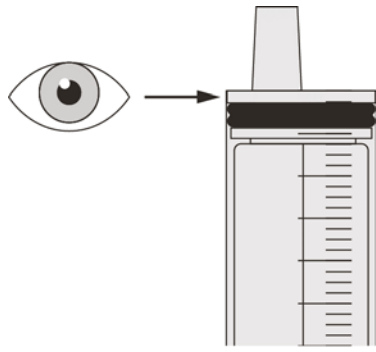

Figure N

Step C2

Check that there is no medicine left in the oral syringe (See Figure N).

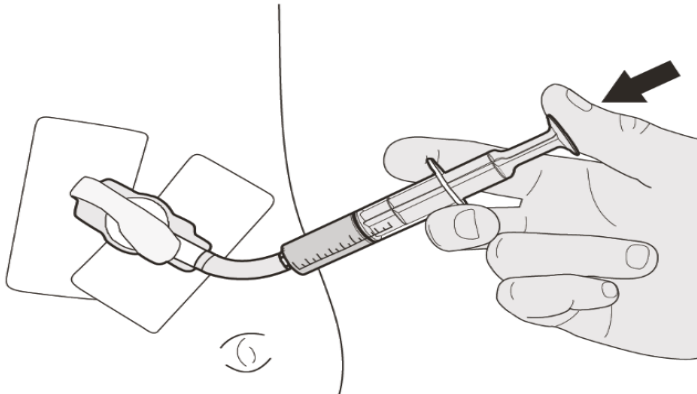

Figure O

Step C3

Flush the gastrostomy tube with 10-20 mL of water right after giving the dose of Evrysdi (See Figure O).

Go to Step E for cleaning of the syringe.

D) How to give a dose of Evrysdi through a nasogastric tube

If you are giving Evrysdi through a nasogastric tube, ask your doctor or nurse to show you how to inspect the nasogastric tube before giving Evrysdi.

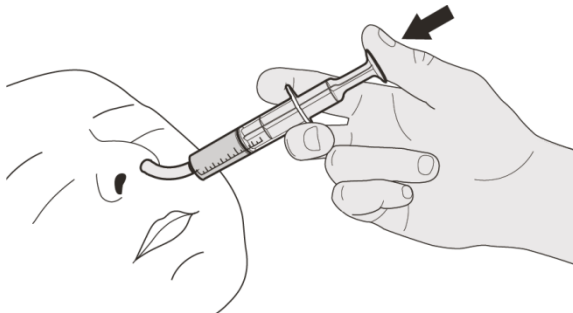

Figure P

Step D1

Place the oral syringe tip into the nasogastric tube. Slowly press the plunger all the way down to give the full dose of Evrysdi (See Figure P).

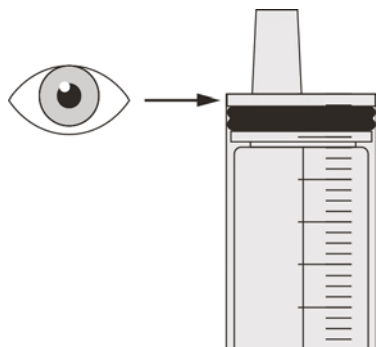

Figure Q

Step D2

Check that there is no medicine left in the oral syringe (See Figure Q).

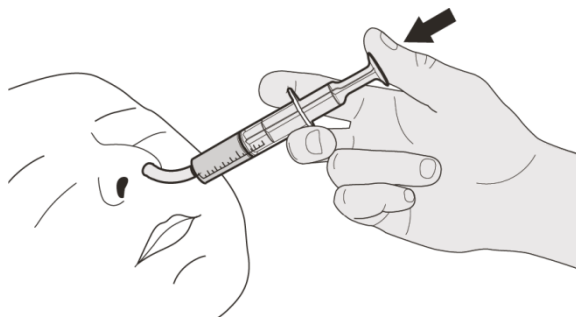

Figure R

Step D3

Flush the nasogastric tube with 10-20 mL of water right after giving the dose of Evrysdi (See Figure R).

Go to Step E for cleaning of the syringe.

E) How to clean the oral syringe after use

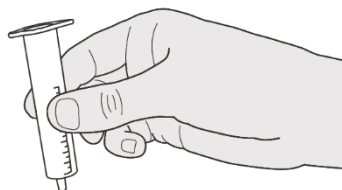
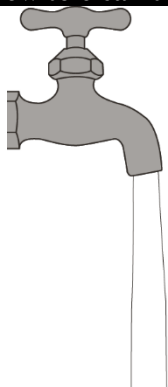

Figure S

Step E1

Remove the plunger from the oral syringe.

Rinse the oral syringe barrel well under clean water (See Figure S).

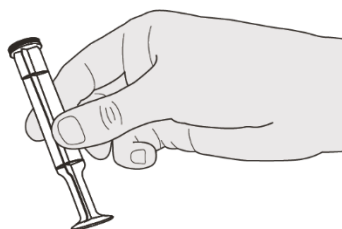
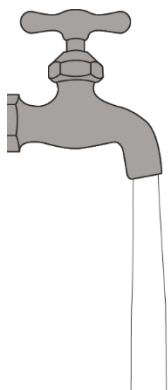

Figure T

Step E2

Rinse the plunger well under clean water (See Figure T).

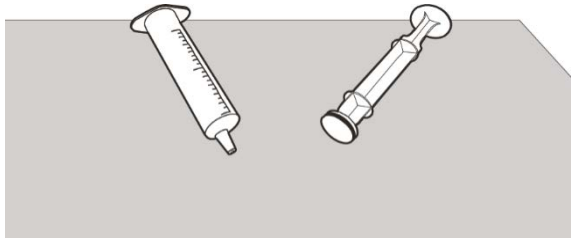

Figure U

Step E3

Check that the oral syringe barrel and plunger are clean.

Place the oral syringe barrel and plunger on a clean surface in a safe place to dry (See Figure U).

Wash your hands.

Once dry, reassemble the plunger into the oral syringe barrel and store the syringe with your medicine.

Instructions For Constitution

Evrysdi 0.75 mg/mL

powder for oral solution

risdiplam

Instructions for Constitution

(FOR HEALTHCARE PROFESSIONALS [EG. PHARMACISTS] ONLY)

Each Evrysdi carton contains (See figure A):

1. 1 Cap
2. 1 Evrysdi bottle
3. 1 Oral syringe 12 mL (in pouch)
4. 2 Oral syringes 6 mL (in pouches)
5. 2 Oral syringes 1 mL (in pouches)
6. 1 Press-in bottle adaptor
7. 1 Package Leaflet (not shown)
8. 1 Instructions for Constitution (not shown)
9. 1 Instructions for Use (not shown)

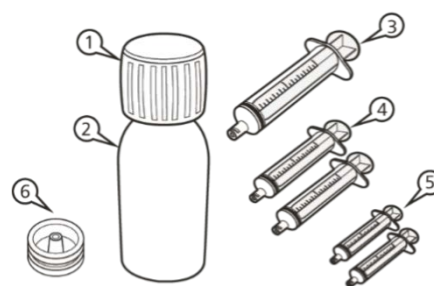

Figure A

Important information about Evrysdi

- **Avoid inhaling** Evrysdi powder.
- **Use gloves.**
- **Do not** use if the powder expiry date has passed. The powder expiration date is printed on the bottle label.
- **Do not** dispense the constituted solution if the solution's Discard After date exceeds the original powder expiration date.
- **Avoid getting contact** with the medicine on your skin. If the medicine gets on your skin, wash the area with soap and water.
- **Do not** use the medicine if any of the supplies are damaged or missing.
- Use Purified Water or Water for Injection to constitute the medicine.
- Do not add oral syringes other than the ones provided in the carton.

How to store Evrysdi

- Store the powder (unconstituted medicine) at room temperature and keep it in the carton.
- Store the solution (constituted medicine) in a refrigerator (2 to 8°C) and keep it in the carton upright.
- Keep the oral solution in the original bottle and always keep the bottle in an upright position with the cap tightly closed.

Constitution

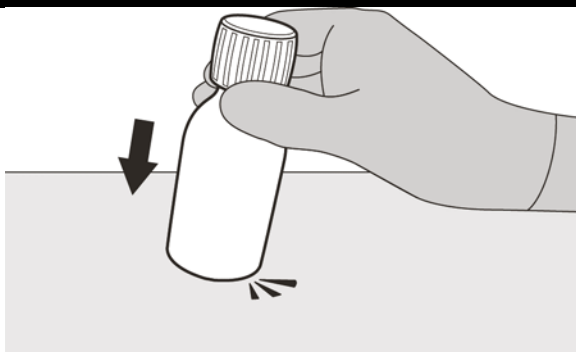

Figure B

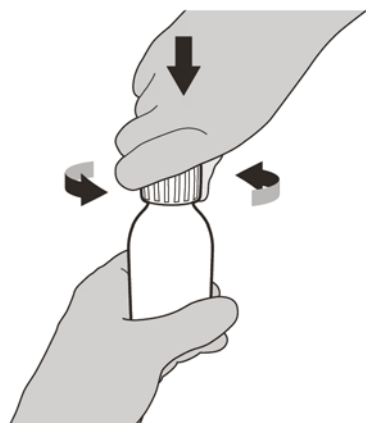

Figure C



Figure D

Step 1

Gently tap the bottom of the bottle to loosen the powder (See Figure B).

Step 2

Remove the cap by pushing it down and then twisting to the left (counter-clockwise) (See Figure C). Do not throw away the cap.

Step 3

Carefully pour 79 mL of Purified Water or Water for Injection into the medicine bottle (See Figure D).

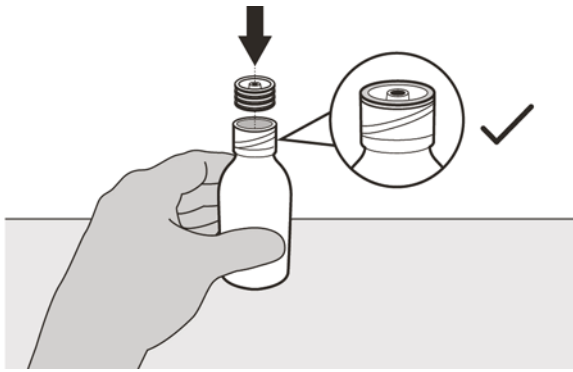

Figure E

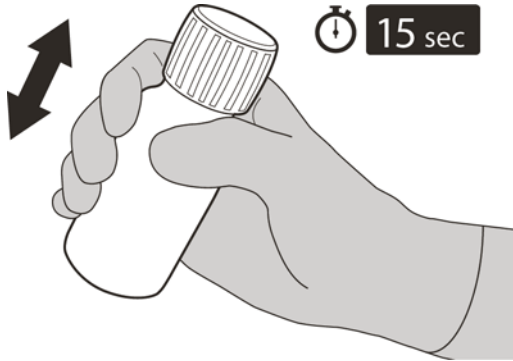

Figure F



Figure G

Step 4

Hold the medicine bottle on a table with one hand.

Insert the press-in bottle adaptor into the opening by pushing it down with the other hand. Ensure it is completely pressed against the bottle lip (See Figure E).

Step 5

Put the cap back on the bottle. Turn the cap to the right (clockwise) to close the bottle.

Ensure it is completely closed and then shake well for 15 seconds (See Figure F).

Wait for 10 minutes. You should have obtained a **clear solution**.

Afterwards, shake well again for another 15 seconds.

Step 6

Calculate the Discard After date as **64 days** after constitution (Note: the day of constitution is counted as day 0. For example, if constitution is on the 1st of April, the Discard After date will be the 4th of June).

Write the Discard After date of the solution on the bottle label (See Figure G) and carton.

Put the bottle back in its original carton, with syringes (in pouches), Package Leaflet and Instructions For Use booklet.

Store the carton in the refrigerator (2 to 8°C).