



EUROPEAN MEDICINES AGENCY
SCIENCE MEDICINES HEALTH

10 October 2016
EMA/156890/2016

Outcome of the European Medicines Agency (EMA) survey on centralised post-authorisation procedures 2015

European Medicines Agency, London, United Kingdom



30 Churchill Place • Canary Wharf • London E14 5EU • United Kingdom

Telephone +44 (0)20 3660 6000 **Facsimile** +44 (0)20 3660 5555

Send a question via our website www.ema.europa.eu/contact

An agency of the European Union



Outcome of the European Medicines Agency (EMA) Survey on centralised post-authorisation procedures

Contents

1. Executive summary.....	2
2. Background, objectives and scope of the survey	2
3. Methodology	3
4. Profile of respondents.....	4
5. Findings from the survey	4
5.1. Feedback from Industry respondents.....	5
5.1.1. <i>Pre-submission phase</i>	5
5.1.2. <i>Validation phase (Type IBs/IIs) / Receipt of submission (PSURs)</i>	6
5.1.3. <i>Evaluation phase</i>	7
5.2. Feedback from EMA respondents.....	8
5.2.1. <i>Pre-submission phase</i>	8
5.2.2. <i>Validation phase</i>	9
5.2.3. <i>Evaluation phase</i>	10
6. Conclusions from the survey	12
7. Survey follow-up actions.....	13
8. Additional remarks.....	14

1. Executive summary

In 2013-14 the Agency initiated a major exercise whereby all the established processes for the evaluation of human medicinal products were reviewed and re-designed with the aim to simplify the existing ways of working and provide better support to its Scientific Committees and the Network.

In that context it was important, in line with EMA stakeholders' management principles, that the Agency gathers feedback from its directly impacted stakeholders further to these changes. An EMA-Industry Survey on centralised post-authorisation procedures was therefore launched in April 2015 to collect feedback from both industry stakeholders and EMA on the level of satisfaction with certain high volume post-authorisation procedures that have been extensively re-designed, namely Type IB variations, Type II variations and PSUR procedures.

The survey results showed a high level of overall satisfaction from both respondents (EMA staff and MAHs) across the three procedures in terms of procedural management, level of interaction and overall communication for the updated procedures. It also identified some areas for further improvement such as proposals for additional simplification and aspects of EMA guidance that necessitated further development.

A number of follow up actions towards improvement of the quality of submission, further increase on consistency and transparency on validation and procedural simplifications have been triggered. All guidance updates and certain of the proposed simplifications in the lifecycle management of the RMP and the quality of the product have been delivered within 6 months from the post-authorisation survey.

2. Background, objectives and scope of the survey

The objective of the EMA-Industry Survey on centralised post-authorisation procedures, launched in April 2015, was to receive detailed performance related feedback from both industry stakeholders and EMA on certain post-authorisation procedures, namely type IB variations, type II variations and PSUR procedures (centrally authorised medicinal products only). The survey was initiated further to EMA re-organisation and re-design and optimisation of the management of procedures during 2014.

The aim was to set a baseline for these procedures and monitor their practical implementation from both perspectives, to enhance mutual understanding of issues arising, to elicit direct and on-going feedback from Marketing Authorisation Holders (MAHs), to increase further the transparency on the interactions between EMA and its Industry stakeholders and, ultimately, to enable continuous improvement of processes and guidance development and/or updates.

3. Methodology

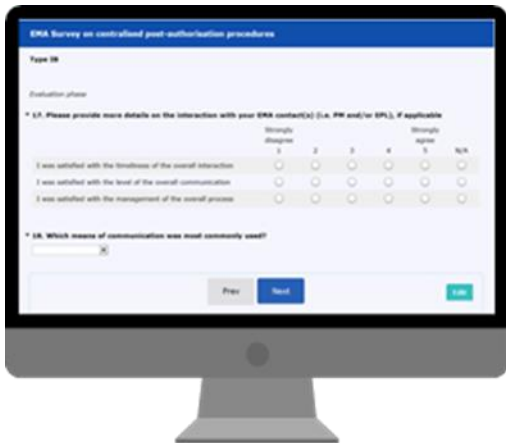

The survey was run online and anonymised. The questionnaire was prepared and mutually agreed between EMA and Industry (EFPIA Working Group) and shared with other Industry Organisations prior to launch. The “Survey Monkey” survey management tool was utilised for this survey.

It included around twenty five questions (*per procedure*) on both qualitative and general procedural aspects of the different phases of the evaluation procedure, namely pre-submission, validation and evaluation phases.

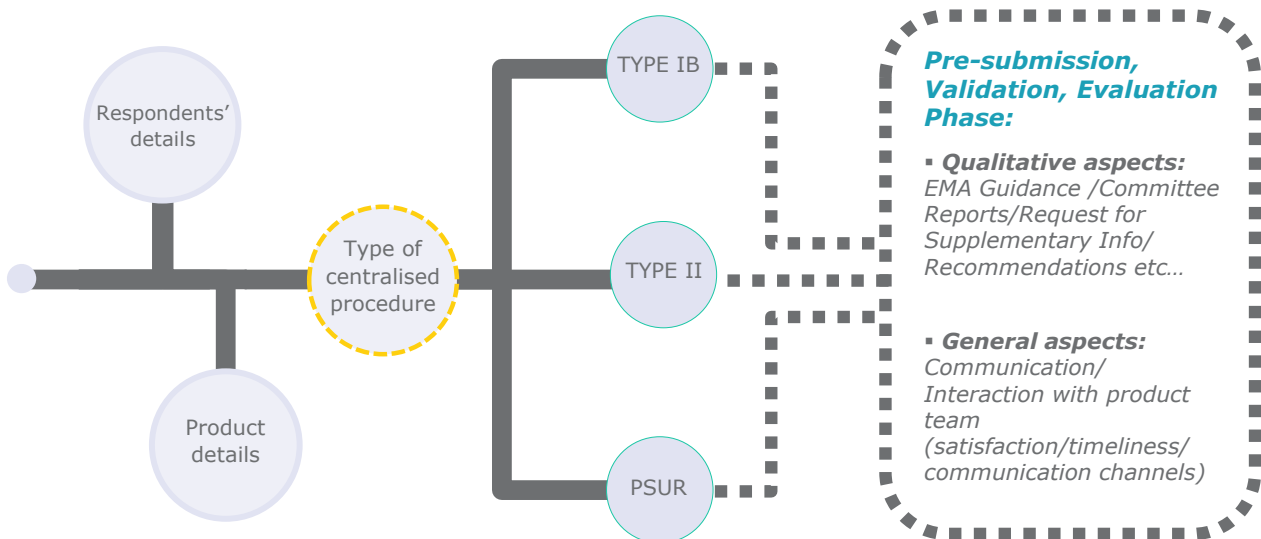

The consultation took place over a 6-month period. It was addressed to MAHs who, at the point of the launch of the survey, had already received a final EMA/CHMP notification/opinion and whose procedures were finalised between 1st April and 30th September 2015.

The survey combined the following response formats, depending on the nature of the question:

- Dichotomous Scale (Yes/No)
- 5-point Rating Scale (Strongly disagree – Strongly agree – Not Applicable)
- Multiple choice and multiple response
- Free text

The outcome of this survey was co-presented by EMA and representatives from Industry associations in the [2nd Industry Stakeholder Platform Meeting / Operation of the centralised procedure on 9th November 2015](#).

4. Profile of respondents

Two hundred and seventy (270) responses were received from EMA staff members and one hundred and ninety six (196) responses from centralised Marketing Authorisation Holders during the six-month period.

The set objective to reach at least 10% of the total annual volume for each of the three procedures was met for Type IBs only. For Type IIs and PSURs, 8% and 7% were reached respectively.

Figure 1: Overall response rate of the survey

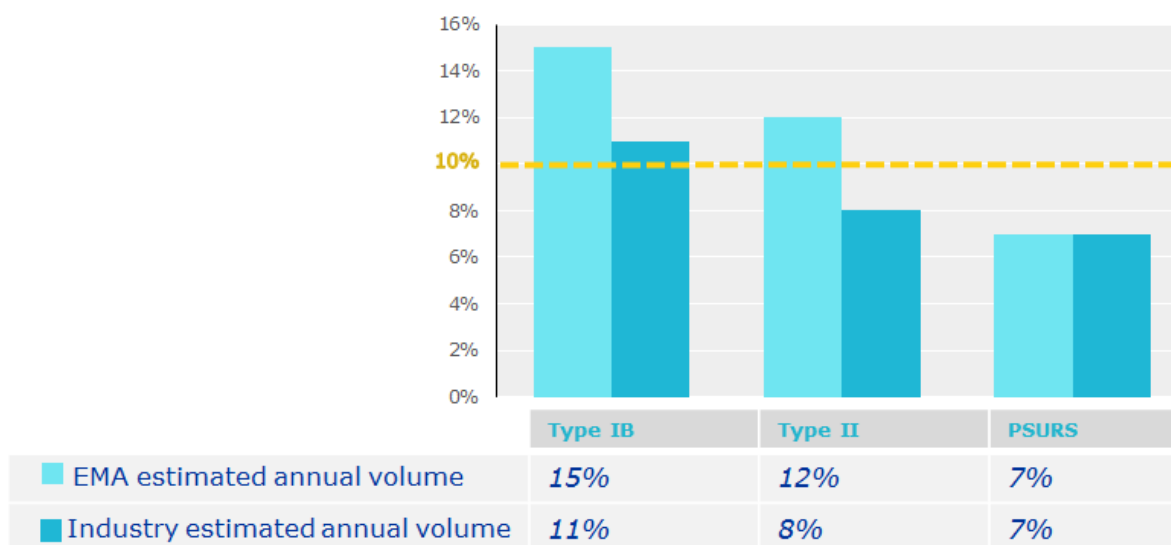

The medicinal products included in this survey data set were for 92% "New Active Substance", 5% generic medicinal products and 3% of those included were biosimilar medicinal products. 12% of them were orphan medicinal products and 1% Advanced Therapy Medicinal Products.

5. Findings from the survey

The survey had in scope certain post-authorisation procedures (Type IB/II variations and PSURs (CAPs only)) which had been redesigned with optimisations introduced during 2014. The survey covered the different phases of each procedure namely pre-submission, validation/receipt of submission and evaluation and mainly focused on aspects relevant to the interface of EMA with Marketing Authorisation Holders such as communication/interaction between EMA product team and applicants. It also covered specific procedural aspects that were subject to redesign, newly established and/or optimised (e.g. establishment of pre-submission query service, EMA Guidance, single template committee reports).

The following sections summarise the results of the survey questions from both Industry and EMA staff dealing with procedures.

5.1. Feedback from Industry respondents

This section includes the feedback of the survey completed by the Marketing Authorisation holders who received an opinion/notification of a procedure under the scope of this survey.

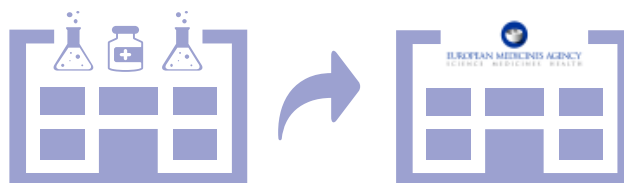

5.1.1. Pre-submission phase

EMA Post authorisation guidance

The majority of Industry respondents (80-90%, n=193) had used the EMA post-authorisation guidance (Q&A) in the preparation of their submissions. This percentage was lower for specific guidance such as the "EMA practical guidance on the application form for centralised Type IA and Type IB variations" which was only used by 65% (n=95) of applicants.

Results from Industry respondents showed that the EMA post authorisation guidance for the referred procedures is generally clear and addresses the needs of applicants. Less than 10% of respondents considered that the guidance was not clear or that it did not address their needs Most for preparation of the submissions. The MAHs also identified some areas where further clarification could be developed such as procedural and regulatory guidance on the submission of complex RMP changes, guidance on submission of results of Post Authorisation safety studies (PASS), and the procedural handling of SmPC changes after a PRAC recommendation on a PSUR.

EMA Pre-submission queries service

The pre-submission queries service was established by EMA as an additional service to applicants in support to the preparation of their submissions of post-authorisation procedures. The service aims to provide replies to queries that marketing authorisation holders (MAHs) may have during the pre-submission phase. A dedicated mailbox was created on EMA website for each procedure supported by a specialised team of procedure managers endeavours to respond within 5 working days of the receipt of the query.

The pre-submission query service was not used by the majority of applicants when preparing their applications. Only 26%, 40% and 11% of MAHs declared to have submitted a question to the Service prior to filing a type IB, Type II or PSUR procedure respectively (n=94; n=62; n=35).

MAHs that have used the Service were overall very satisfied with the responses received in terms of clarity, completeness and timeliness. Applicants that used the service largely considered that the responses provided by EMA were generally timely (within the 5 working days) in more than 75% of cases.

Figure 2: Use and level of satisfaction of the Pre-submission query service

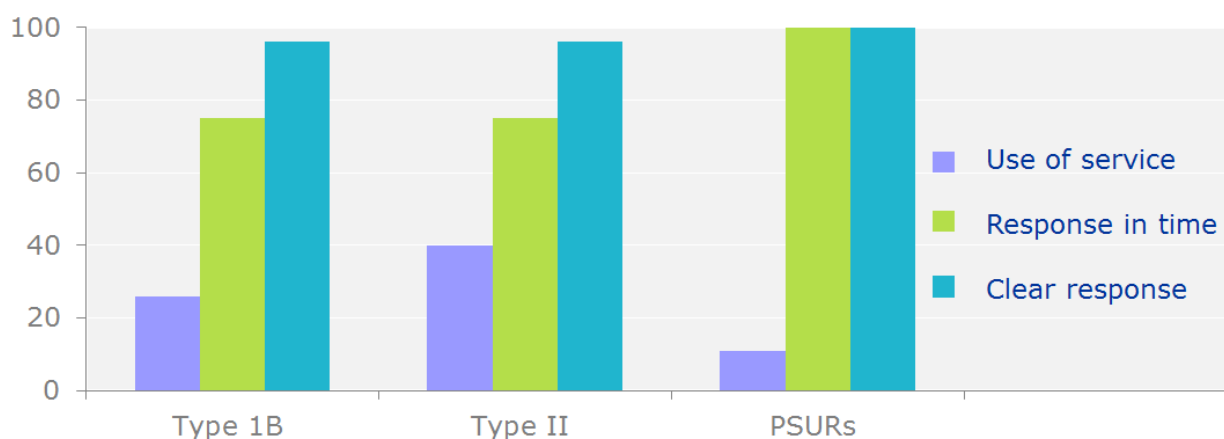

With regards to the content of the responses, >90% (n=52) of MAHs considered that the responses were clear and addressed all the issues raised by applicants. These results were consistent across the procedures.

Results also show a high level of awareness of applicants regarding which mailbox to use for submitting their queries to EMA for type IBs (92%, n=24) and type IIs (96%, n=24) and to a lesser extent for PSURs (50%), although the sample size in this case was limited (n=4).

In the comments received, applicants also indicated that in addition to PQS, further dialogue was required in specific procedures to quickly resolve queries and avoid subsequent delays during the validation phase.

5.1.2. Validation phase (Type IBs/IIs) / Receipt of submission (PSURs)

In the case of Type IB procedures, the Agency endeavours to finalise validation or issue a request for supplementary information within 7 calendar days upon receipt of a submission. For Type IIs, validation times range between 11 to 16 calendar days according to the start dates detailed in the different timetables for Type IIs published on EMA website. The different timetables depend on the submission date of the procedure, length and type of type II procedure (e.g. extension of indication).

In the survey, MAHs reported that validation generally was performed in a timely manner although delays were reported in 16% of Type IBs (n=92) and 7% of Type IIs (n=59). Causes of the delays reported were due to the complexity of the some grouped submissions and the exceptional need for a second request for additional information. Some respondents also commented that the reasons for delay were not always provided to the applicant, and that they had to prompt the Agency as no feedback had been received within the expected timeline.

Applicants noted that high levels of clarity (95%, n= 151) with regards to the administrative and documentation aspects checked during validation. Within the general comments, applicants highlighted the need to ensure consistency across procedures during validation and noted occasional requests for information already supplied in the application.

5.1.3. Evaluation phase

The main contact point during the procedures within the scope of this survey is the Procedure Manager. Depending on the complexity of the procedure, additional team members such as the EPL or relevant specialists may participate in different phases.

There was a high level of satisfaction with the interactions with the Agency during the procedure (>85 % agreed or strongly agreed). The results were consistent across the different procedures in terms on timeliness of the communication, the level of communication during the procedure and the overall management of the procedure by the Agency.

Results also showed a high level of clarity by Applicants on the different contact points for each procedure. The communication took place via email/Eudralink in 100% of cases, with the additional use of phone in 10-20% of cases.

Figure 3: Means of communication most commonly used during the procedure

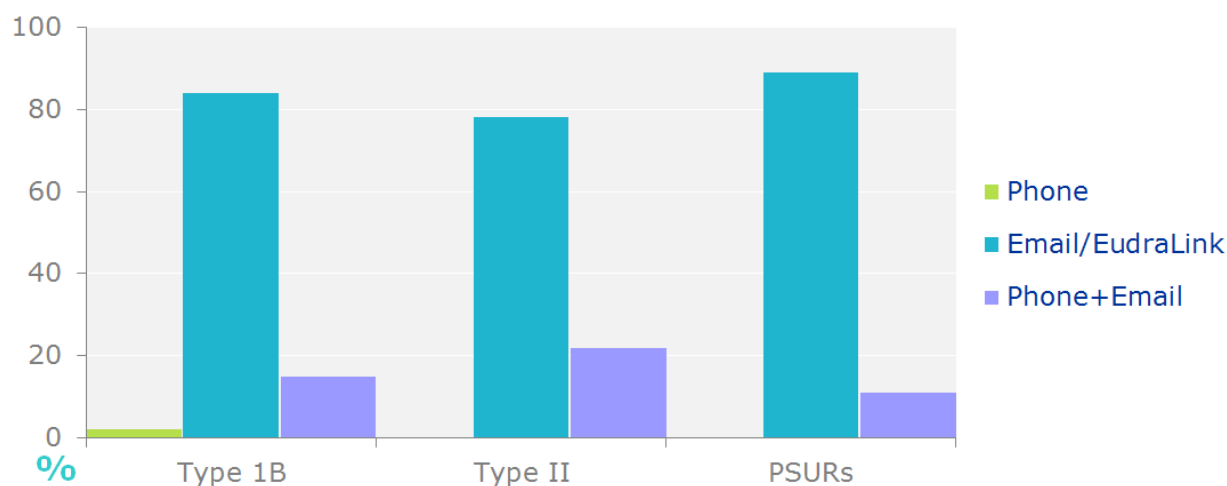

One of the improvements included during the revision of EMA procedures was the use of a single Assessment report template throughout the procedure that reflects the evolution of the assessment during the different steps of the procedure.

A high proportion of respondents (~ 90 % overall satisfaction, n=180) highly rated the quality of the newly introduced single assessment reports and agreed that the new structure is clear and easy to follow. Furthermore, applicants also rated very positively (>80%) the content of the assessment report considering that the conclusions of the report, the requests for supplementary information and/or subsequent regulatory actions (where applicable) were adequately justified within the report. In the specific case of PSURs, results also reflect the applicant's satisfaction (>80%) on the clarity of the report on the issues which needed an immediate response.

Applicants noted a high level of clarity (85-98%) on the relevant timelines for the different steps of the procedures. These are published on EMA's website and in the case of Type IIs and PSURs they are also communicated to applicants at the start of the procedure.

An identified area for improvement was the need to communicate late circulation of the Rapporteur's assessment reports to the applicants which was reported in almost 20% of Type IIs and 33% of PSURs. In more than 10% of Type IIs and almost 20% of PSURs additional updated ARs were

circulated, normally due to general updates following MAH responses. These updated reports provided the clarification of minor issues and did not have a negative impact on the procedure timelines.

In cases where the product information was affected, the comments on the product information sometimes were considered to not be sent out early enough to facilitate discussion (Type IIs 22%, n=37; PSURs 14%, n=9) and scope for improvements in this particular aspect was highlighted.

The receipt of most Type II and PSUR opinion took place within one day after opinion. In The case of PSURs a significant proportion (almost ¼) were received later than 4 days post opinion. Overall Type IB notifications were issued within 30 days with occasional reports of delays.

Figure 4: Time of Receipt of CHMP Opinion for PSURs and Type IIs

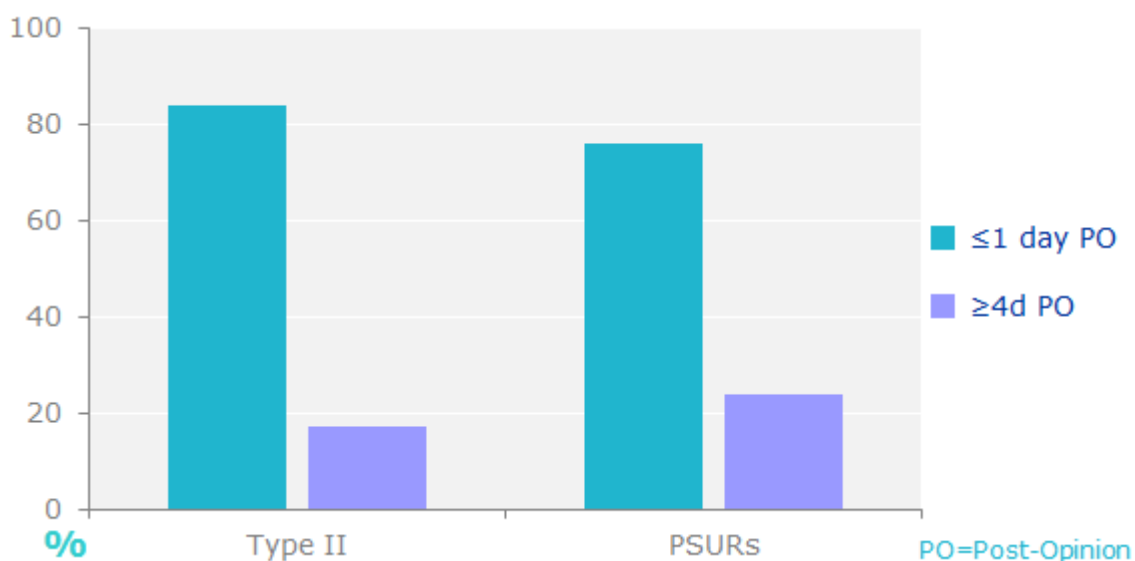

5.2. Feedback from EMA respondents

This section includes the feedback of the survey completed by the Procedure managers with the support of other members of the product team when involved in the handling of the produce (e.g. EPL, specialist).

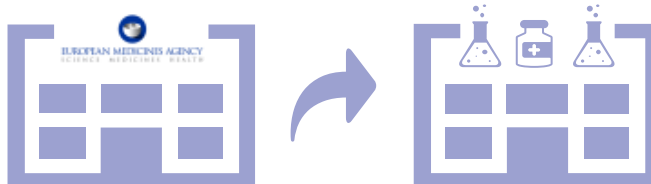

5.2.1. Pre-submission phase

The majority of MAHs (80%, n= 98) are already aware of the Post-Authorisation Guidance (Q&A) available on the EMA website but contacted the pre-submission service for additional aspects not covered in the guidance or to seek confirmation of their interpretation according to comments provided from Procedure Managers in the survey.

The majority of MAH requests were clear in the initial request sent to EMA with all supportive information needed for an adequate preparation of a reply.

Figure 5: Level of satisfaction of PQS Queries received

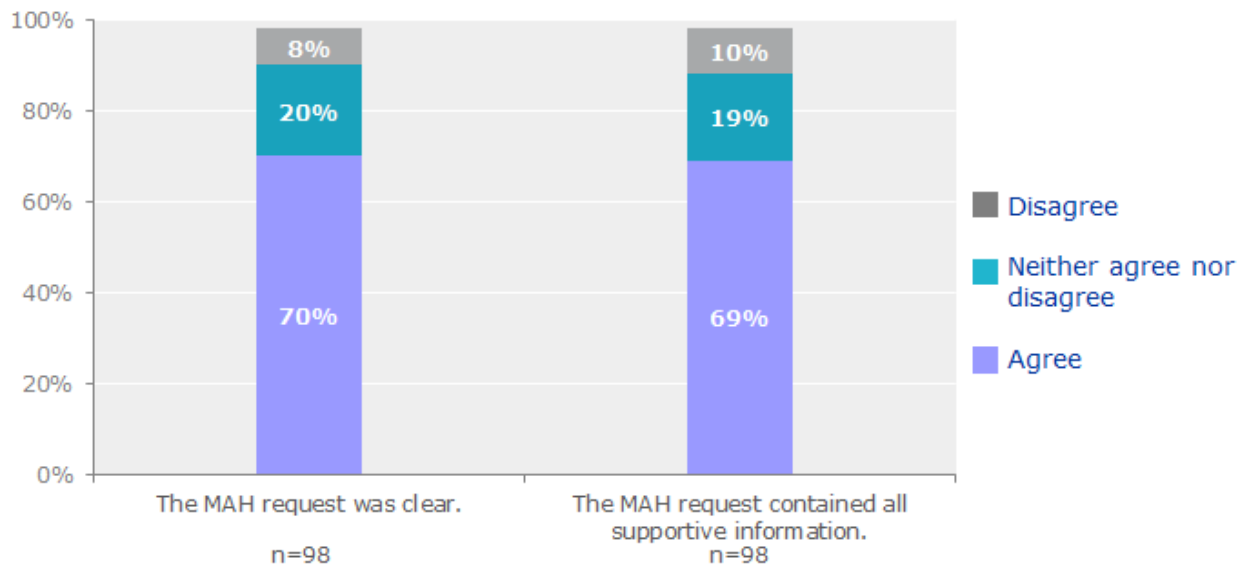

5.2.2. Validation phase

Receipt of application

From the procedures analysed during the survey, EMA staff identified that pre submission advice had been sought in at least 24% of Type IBs, 16% of Type IIs and 20% of PSURs (n= 132; n=97 and n=40 respectively). The majority of MAHs (87%, n=53) had followed the pre-submission advice provided by the pre-submission query service. Furthermore, in most cases the data received at time of submission was fully in line with the information provided by applicants in the initial query to the pre-submission query service as detailed below.

According to the responses from EMA staff, 84% of Type IBs (n=132) were validated (or request from supplementary information) issued within 7 calendar days of receipt of the submission. In the case of Type IIs, 100% of procedures were validated within the deadlines as published on EMA’s website (n=97).

Overall, the procedure managers were satisfied with the quality of submissions received from applicants, although requests for supplementary information often had to be issued due to deficiencies in the application form, incomplete documentation received, incorrect classification of changes, and unclear or incomplete description of changes within the precise scopes.

Figure 6: Main common deficiencies identified in validation phase of Type IBs and Types IIs

TYPE IB (n=132)	TYPE II (n=97)	Comments on quality of MAA submission
23%	8%	<i>Deficiencies in the application form</i>
21%	12%	<i>Incomplete documentation</i>
13%	4%	<i>Incorrect classification of changes</i>
6%	5%	<i>Precise scope not clear or incomplete</i>

With regards to PSURs, high level of satisfaction in the quality of submissions received from applicants was reported. In 97% of cases (n=37) the documentation at the initial submission was complete and presented in a satisfactory way. In 84% of cases, deficiencies in the cover letter template were identified.

5.2.3. Evaluation phase

The contact point for the procedure is the Procedure Manager, although communication of the applicant with EPL or specialist takes place for certain steps depending on the level of complexity of the procedure.

As shown in the graphics, the results from the survey showed overall satisfaction by EMA staff in the timeliness and the level of communication with MAHs consistently across the three procedures.

There was variability in the interactions and the communication between EMA staff and MAHs depending on the type and complexity of procedures taking place in 38% of Type IBs, 86% of Type IIs, 75% of PSURs procedures. Consistent with the results from Industry respondents, the main means of communication across all procedure types were by email/Eudralink, with interaction by phone in 16% of cases.

Figure 7: Satisfaction in the timeliness and level of communication

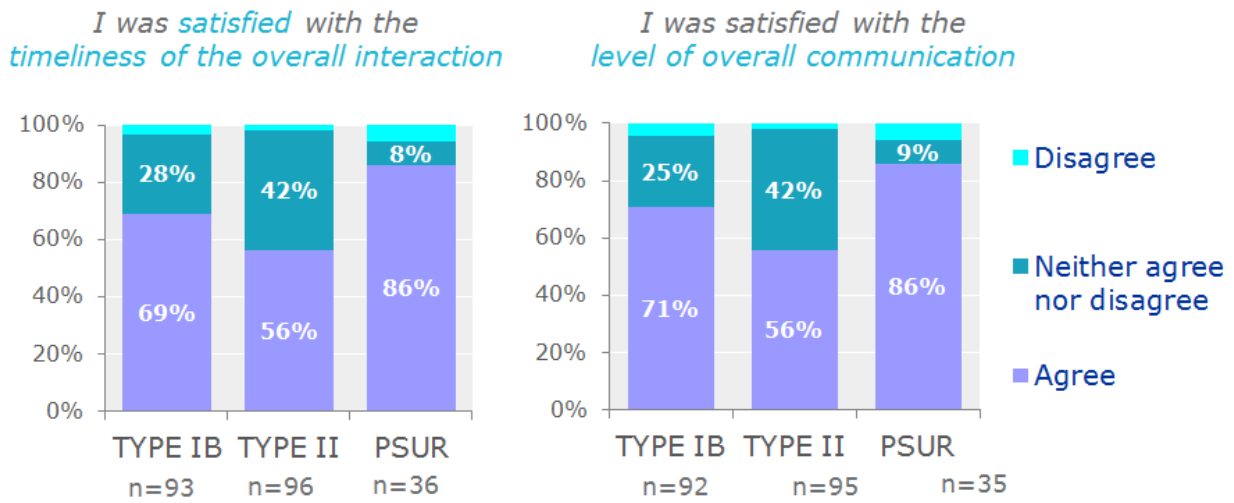

Results from EMA respondents confirmed that the circulation of Assessment Reports took place according to timelines in the majority of cases (95% of type IIs (n=97) and in 78% of PSURs (n=37)). Delays in PSUR Assessment Report circulation were identified in 78% of procedures, although the limitation to the sample size analysed is acknowledged. According to the comments provided in the survey, these reported delays were mainly due to the late circulation of Assessment Report from Rapporteur as well as longer internal EMA confidentiality checks.

Figure 8: Timeliness of circulation of assessment reports during the procedure

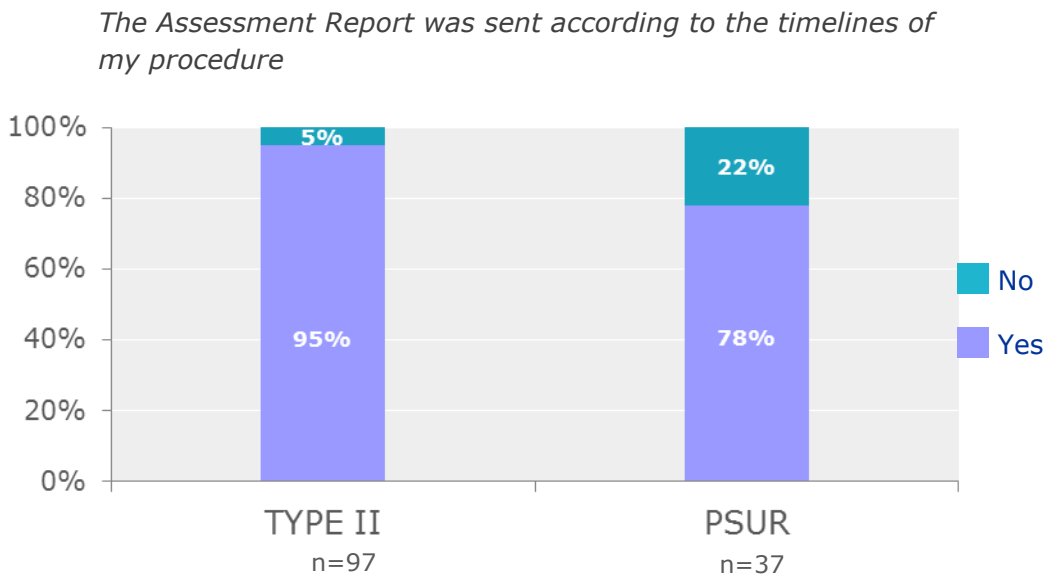

EMA respondents were satisfied overall with the timeliness of the interaction with MAHs in the discussion of comments and updates to the Product Information (PI) during the type II and for PSUR procedures with sufficient time allowed for discussion during the procedure as shown in the results below.

Where applicable, comments to the Product information were sent early enough to facilitate discussion during the procedure.

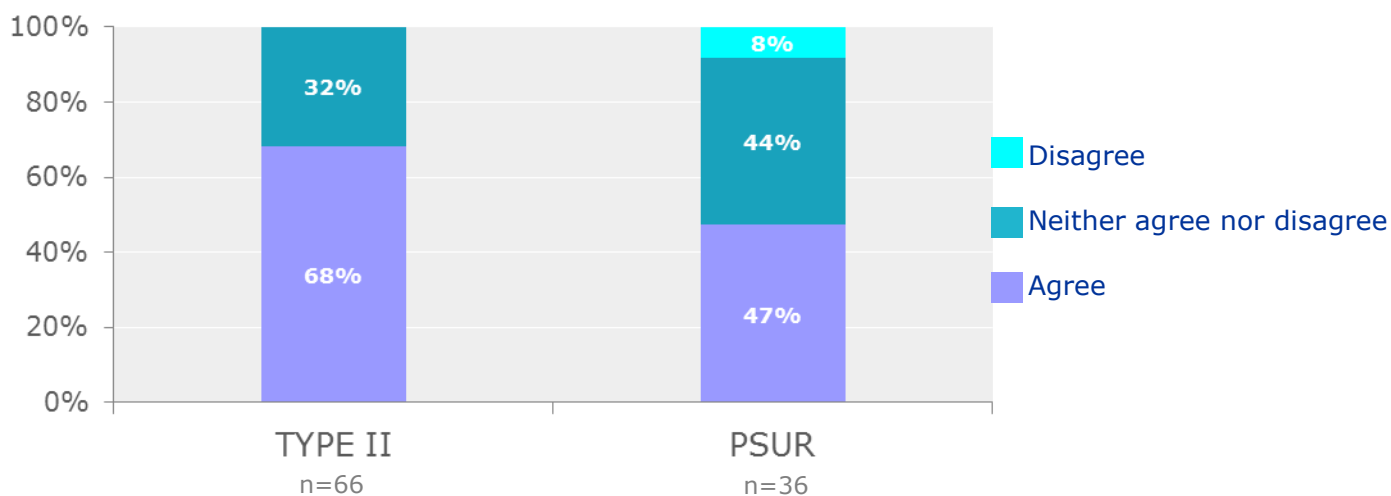

With regards to the finalisation of the procedure, results from EMA staff show that the Type II opinions and the Recommendation/opinions of PSURs were issued within the legal deadlines in 100% of procedures analysed. In the case of Type IB notifications, 97% of Type IB notifications were issued in less than 30 days. According to comments in the survey, the reported delays were mainly due to pending clarifications from MAHs on minor issues to avoid requests for supplementary information and or need to update documentation at finalisation (e.g. submission of updated Product Information)

6. Conclusions from the survey

Following the redesign and optimisation of the post authorisation procedures included in the scope of this survey (Type IBs, Type IIs and PSURs), both respondents (EMA staff and MAHs) overall highlighted a high level of satisfaction across the three procedures in terms of procedural management, level of interaction and overall communication for the updated procedures. The survey also identified some potential areas for further improvement, procedural simplification and where additional guidance should be developed.

- The results showed: An overall satisfaction (90 %) in the content and the clarity of the EMA pre-submission guidance.
- A High level of satisfaction (70 %) in the clarity and completeness of the queries received from applicants at the EMA Pre-submission Queries Service as well as in the timeliness, quality of reply and level of support provided by EMA.
- The quality of the submissions received in these post authorisation procedures was highly rated overall although some deficiencies were encountered during the validation.
- Both EMA and industry rated positively the timeliness, level of communication and the management of the post-authorisation procedures (>90%).

- The legal evaluation timelines were met overall in almost all the procedures under the survey. In most cases (>85%) validation was accomplished according to the timelines published on EMA's website or in line with internal EMA performance targets.
- Industry provided positive feedback (~90%) on the new structure and the clarity of the new single Assessment Report templates.

Respondents highlighted the following points for improvement, some of which have already been addressed (see section 7)

- Some areas in the EMA post-authorisation guidance were identified for further update and/or for new development. These include procedural and regulatory guidance on the submission of complex RMP changes, guidance on submission of results of Post Authorisation safety studies (PASS), and the procedural handling of SmPC changes after a PRAC recommendation on a PSUR.
- The pre-submission query service (PQS) was rated at a high level of satisfaction by applicants that had used the Service. Results from the survey highlighted the challenge of maintaining the achieved timeliness and the quality of responses to avoid any delays in submissions by applicants.
- During the validation phase/receipt of submissions, key areas for further simplification were identified as follows: to increase the quality of submissions, reduce requests for supplementary information, and provide consistent and timely communication of the validation outcomes.
- The timely circulation of assessment reports, comments on the product information and outcomes of the procedure have been identified as key areas to focus on during the evaluation pause of the procedures.

7. Survey follow-up actions

Based on the feedback of the survey, the following actions have been put in place, are currently ongoing or planned to address the potential areas identified for improvement:

- In April 2016, the procedural and regulatory post authorisation guidance (Q&A) for [Type IBs](#), [Type IIs](#) and [PSURs](#) on EMA's website were updated to reflect the gaps identified in the survey as well as frequently asked questions received in the pre-submission query service. In addition, two new dedicated sections providing specific [guidance related to the submission of RMP changes](#) and to the [classification of changes at post-authorisation](#) were [published on EMA's website in June 2016](#). These new guidance documents also include a simplified approach for handling complex RMP submissions and quality related changes.
- An initiative to reduce the number of issues and to improve the quality of submission was launched in Q1 2016 (see [presentation](#)). Following an analysis of the requests for supplementary information for Type IBs, the Agency engaged with some MAHs of generic medicinal products to discuss the main challenges that applicants face in the preparation of submissions. Feedback from these meetings will be taken into account in the development of further guidance.
- In addition, the Agency is preparing a webinar to address the most common shortcomings in variation submissions. This webinar will take place in Q3/Q4 of 2016.
- With the aim of increasing transparency and consistency during validation of post authorisation procedures, the Agency has published pre submission checklists to be used by applicants when

preparing their submissions. Validations checklist, for [Type IAs](#) and [Type IBs](#) were published in March 2015 and [Renewals](#), [Annual renewals](#) and [Annual reassessment](#) in October 2016.

- The Agency is also monitoring the circulation of assessment reports. In the case of PSURs, a 30 day commenting period for MAHs following circulation of a preliminary assessment report is always ensured.
- As part of the continuous improvement of our procedures, the Agency is also undertaking other initiatives in the procedural management of post authorisation procedures such as extended weekly submissions of Type IIs led by PRAC and an additional monthly linguistic review cycle.

In June 2016, a new operating model for procedure management to improve support for evaluation procedures was established ([news item](#)). With the new model procedure managers and procedure assistants will be allocated per product, rather than per procedure, in order to improve the co-ordination of regulatory activities with a product, particularly where multiple regulatory procedures are run in parallel for the same product. The scope of the pre-submission query service was also redesigned as the appointed procedure manager for the product will address directly any pre-submission query related to Type IIs, PSURs as well as extension applications, renewals and PAMs.

8. Additional remarks

This exercise has been undertaken as part of [European Medicines Agency \(EMA\) stakeholder relations management framework](#) and the [Framework for interaction between the European Medicines Agency and industry stakeholders](#) to interact and gather the Agency's feedback from its stakeholders.

This survey was the first to be undertaken by EMA with Industry stakeholders for certain centralised post-authorisation procedures (human medicines) since the reorganisation of EMA in 2014 and the work to [redesign and optimise its procedures](#).

The Agency will continue to review annually through surveys the performance of the evaluation procedures in the pre- and post-authorisation phase. The scope and timing of each survey will be defined based on the findings of previous surveys, feedback at the Industry Platform meetings, changes introduced and the maturity of each procedure.